

EVoline® Wing

Bedienungs- und Montageanleitung
Operating and assembly instructions
Instructions d'utilisation et d'installation

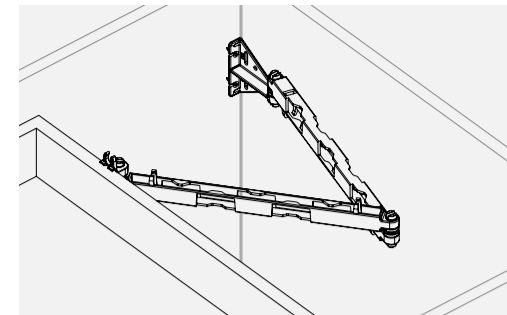

EVoline®

Schulte Elektrotechnik GmbH & Co. KG

Jüngerstraße 21
D-58515 Lüdenscheid
Telefon +49 23 51 / 94 81-0
Telefax +49 23 51 / 4 26 58
Email info@schulte.com

www.evoline.com

Stand 02/2021
Technische
Änderungen
vorbehalten

schulte invented and made by
elektrotechnik Schulte Elektrotechnik,
Lüdenscheid, Germany

7040 2160 0000

Einbauvoraussetzungen | Installation requirements | Exigences d'installation

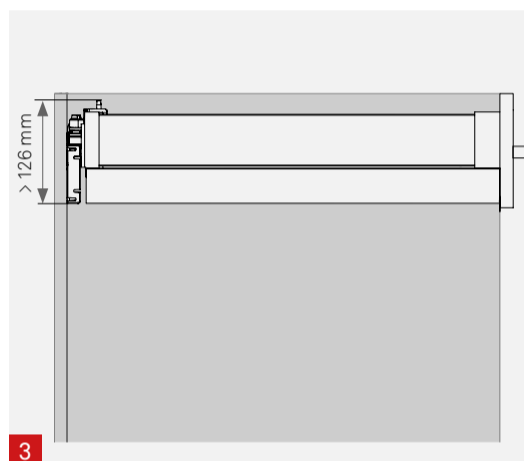
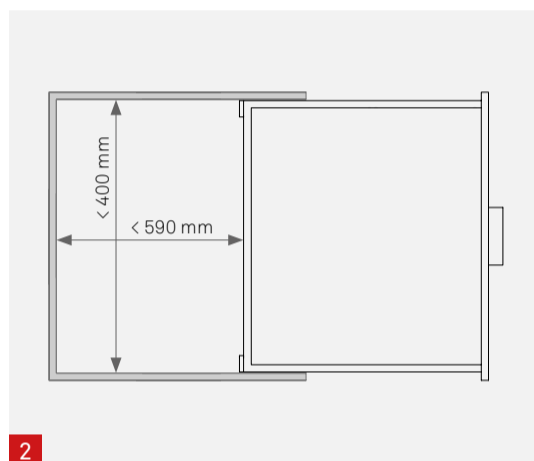
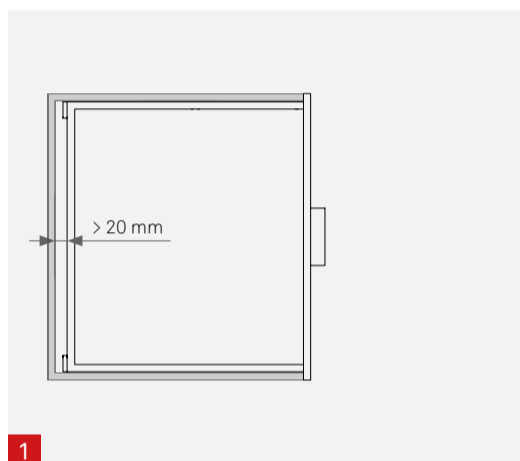

Lieferumfang | Box Contents | Contenu de la livraison

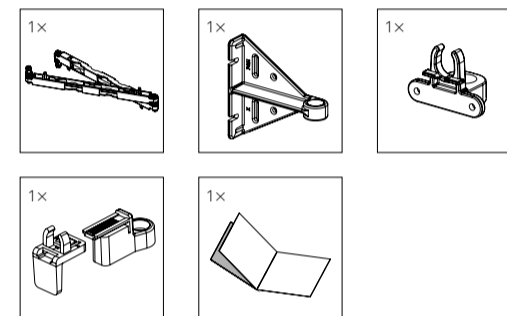

Die aktuellen Bedienungs- und Montageanleitungen finden Sie auf unserer Homepage www.evoline.com/service/downloads.

The current operating and installation instructions can be found on our homepage www.evoline.com/service/downloads.

Les instructions d'utilisation et d'installation sont disponibles sur notre page d'accueil www.evoline.com/service/downloads.

Einbauanleitung | Installation Instructions | Guide d'installation

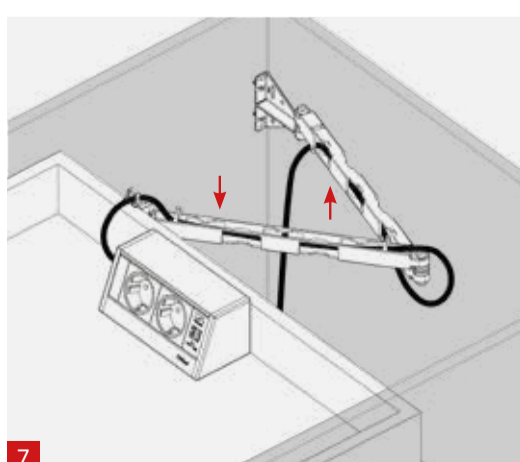
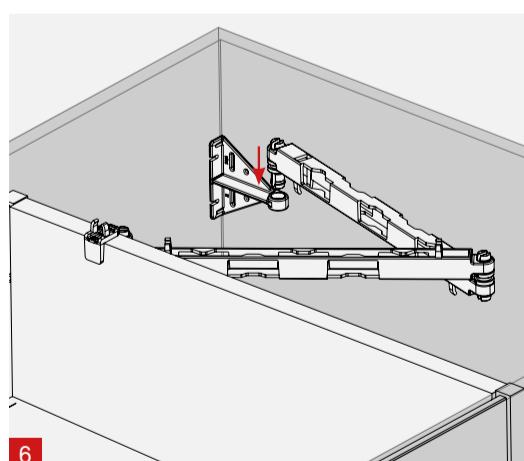
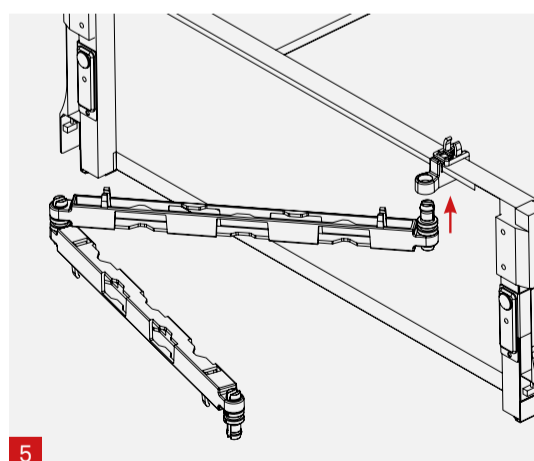
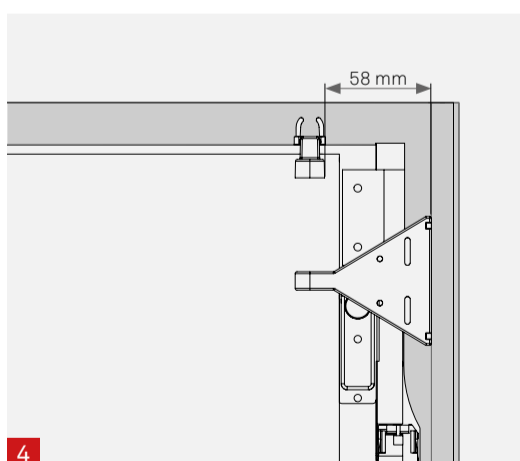
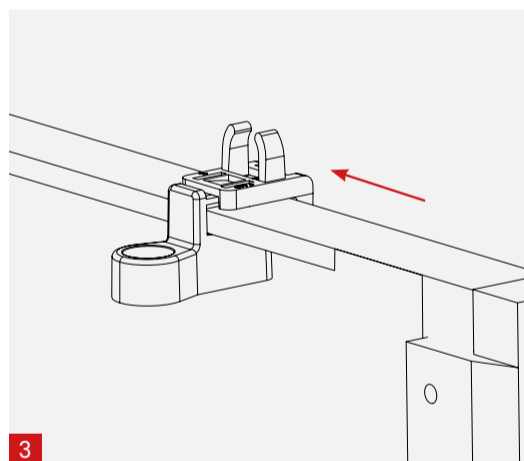
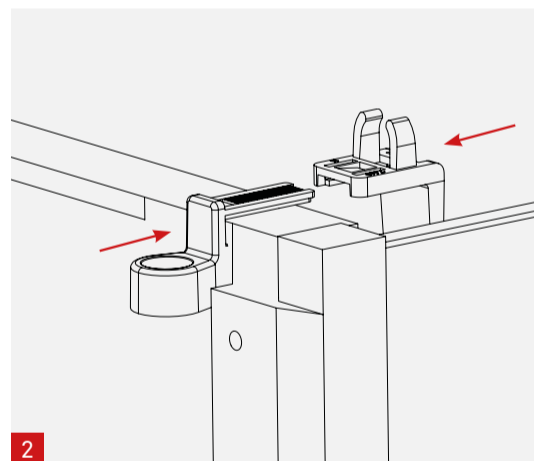
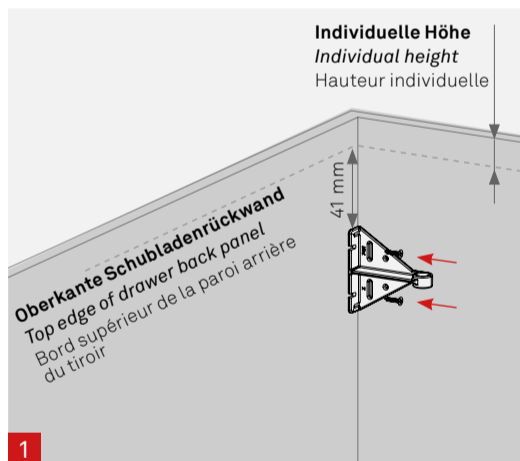

Geeignete Montage an sehr vielen Schubkastenmodellen u.a.:

Suitable for mounting on a wide range of drawer models, inc.:
Convient pour le montage sur une large gamme de modèles de tiroirs, e.a.:

Blum Merivo-Box
Blum Tandembox
Grass Nova Pro
Hettich Typ ArciTech
Hettich Innotech

Hinweis:
Der Wing kann ebenso auf der gegenüberliegenden Seite montiert werden.

Note:
The Wing can also be mounted on the opposite side.

Note:
Le Wing peut également être monté sur le côté opposé.

Maße | Dimensions | Dimensions

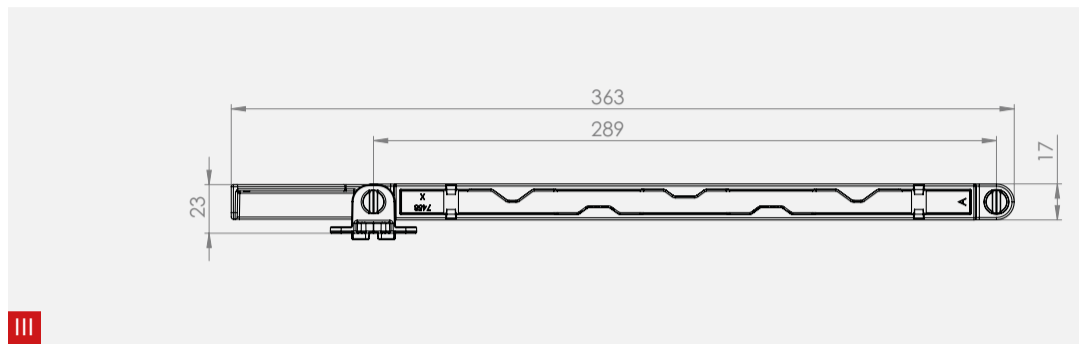
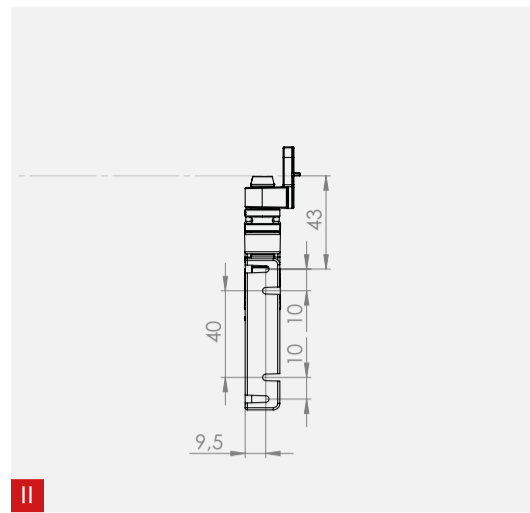
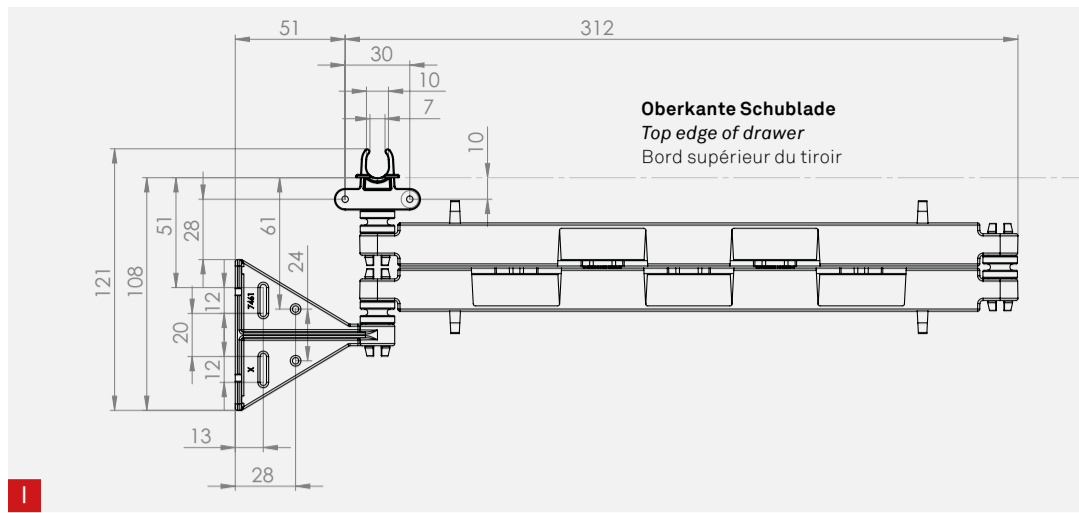

Einbauvoraussetzungen | Installation requirements | Exigences d'installation

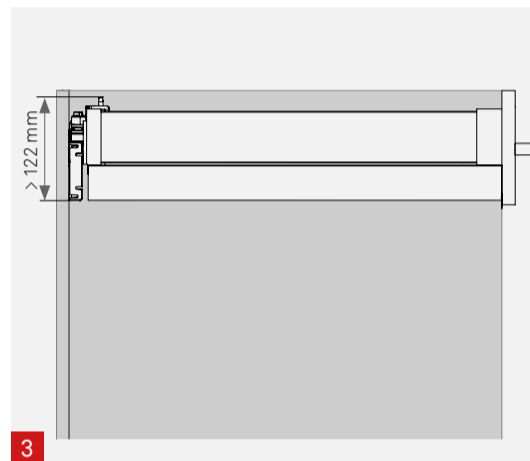
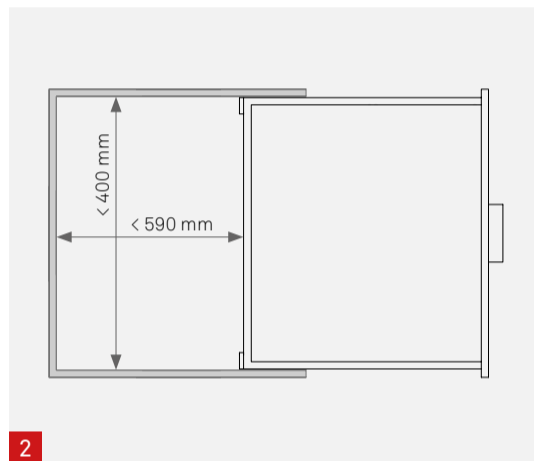
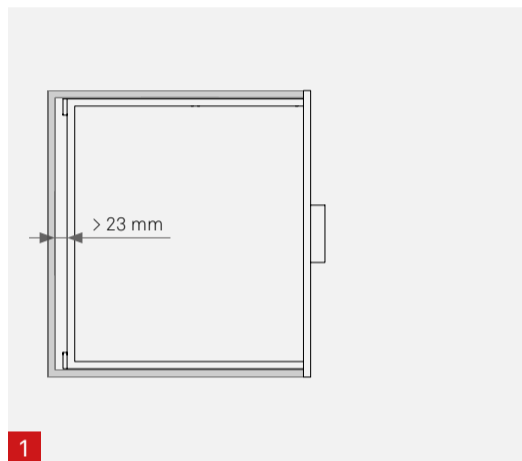

Einbauanleitung | Installation Instructions | Guide d'installation

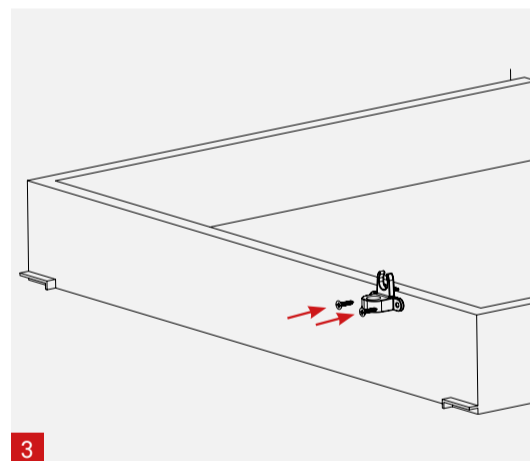
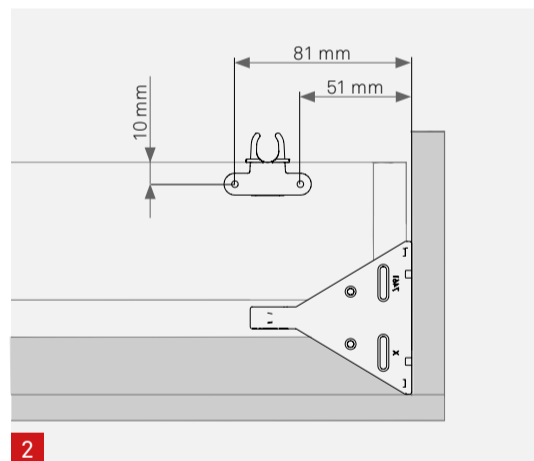
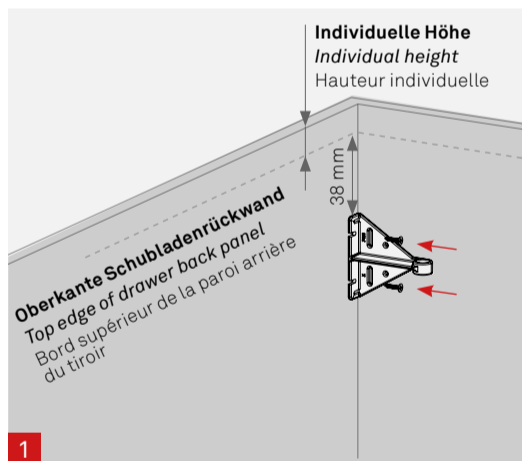

Montage an jedem handelsüblichen Schubkasten mit Holzrückwand möglich.
 Can be fitted to any standard drawer with wooden back panel.
 Montage possible sur n'importe quel tiroir du commerce avec paroi arrière en bois.

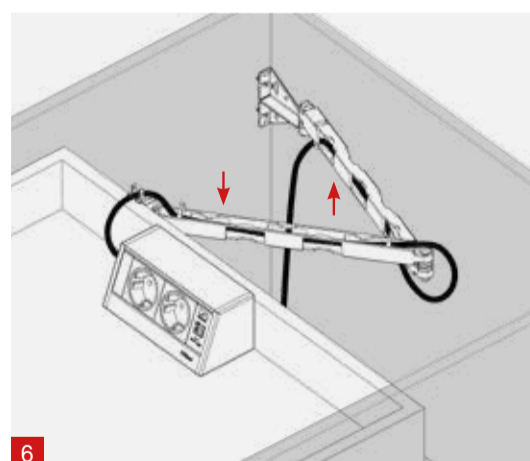
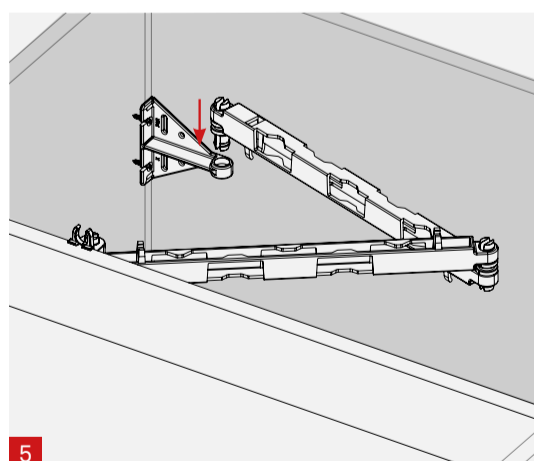
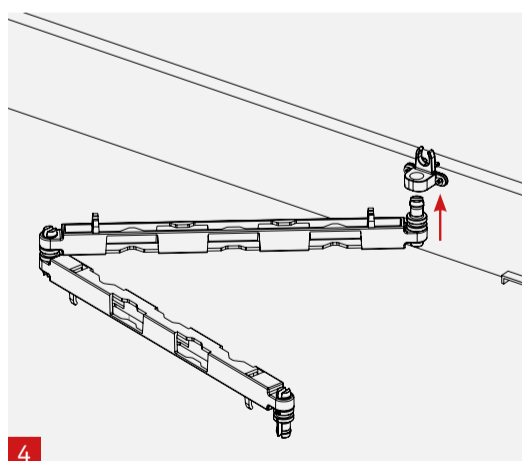

Hinweis:
 Der Wing kann ebenso auf der gegenüberliegenden Seite montiert werden.
Note:
 The Wing can also be mounted on the opposite side.
Note :
 Le Wing peut également être monté sur le côté opposé.