

the
complete
range/

BY FURNIPART

furnipart

furnipart

THE STAR ON YOUR FURNITURE

furnipart was founded in 1977 and has been synonymous with high quality and innovative design ever since. We work extensively from our headquarters in Denmark to ensure all our handles and knobs are to the highest of standards. The designs, dimensions and finishes are thoroughly checked and re-checked to ensure every one of our handles looks and performs to its absolute best.

Over the years, our range has grown considerably in size, and this directory gives you a complete overview of our entire catalogue with information about the designers, materials, dimensions and finish.



/ collection contents

HANDLES	/ page	12
PROFILE REAR MOUNTED	/ page	98
KNOBS	/ page	122
RECESSED HANDLES	/ page	186
ECONOMIC HANDLE DESIGN	/ page	200
CAST IRON	/ page	204
LONG HANDLES	/ page	208
PROFILE REAR MOUNTED - EDGE TO EDGE	/ page	222
PROFILE TOP MOUNTED - EDGE TO EDGE	/ page	236



Model D-Lite - page 138

the complete range/

BY FURNIPART

Deciding on what handle is right for you can be a very daunting task, as we introduce two collections every year with designs ranging from the classic through to innovative and modern.

The complete range/ by furnipart gives you an overview of all our handle designs. From knobs to profiles, they are all here.

Whether you are looking for a handle, profile or knob you can view all our product dimensions, materials and finishes to help you make the right choice.



Model Guild - page 43

HANDLES



CUBICO - page 28

SLIM - page 76

JUNCTION - page 48

HEXA - page 46

SCOPE - page 75

COMPACT - page 27

GATE - page 43

MOULD - page 61

LUCK - page 53

MANGO - page 54



ANGLE

Design furnipart
Material Stainless Steel

Finish	Reference	C/C	L	W	H	D
● Silk Polished	220133096-2535	96	109	-	35	13
● Silk Polished	220133128-2535	128	141	-	35	13
● Silk Polished	220133163-2535	163	176	-	35	13
● Silk Polished	220133192-2535	192	205	-	35	13
● Silk Polished	220133224-2535	224	237	-	35	13
● Silk Polished	220133288-2535	288	301	-	35	13
● Silk Polished	220133320-2535	320	333	-	35	13
● Silk Polished	220133338-2535	338	351	-	35	13
● Silk Polished	220133352-2535	352	365	-	35	13
● Silk Polished	220133384-2535	384	397	-	35	13
● Silk Polished	220133388-2535	388	401	-	35	13
● Silk Polished	220133416-2535	416	429	-	35	13
● Silk Polished	220133438-2535	438	451	-	35	13
● Silk Polished	220133448-2535	448	461	-	35	13
● Silk Polished	220133480-2535	480	493	-	35	13
● Silk Polished	220133488-2535	488	501	-	35	13
● Silk Polished	220133512-2535	512	525	-	35	13
● Silk Polished	220133640-2535	640	653	-	35	13
● Silk Polished	220133672-2535	672	685	-	35	13
● Silk Polished	220133736-2535	736	749	-	35	13
● Silk Polished	220133832-2535	832	845	-	35	13
● Silk Polished	220133988-2535	988	1001	-	35	13



ART

Design Kamper Form
Material Cast Iron

Finish	Reference	C/C	L	W	H	D
● Black	300020096-9005	96	117	28	30	-



BASE

Design Steve McGugan
Material Zamac

Finish	Reference	C/C	L	W	H	D
● Antique Grey	542960160-22	160	172	12	32	-
● Antique Brown	542960160-23	160	172	12	32	-
● Inox Look	542960160-66	160	172	12	32	-
● Antique Grey	542960320-22	320	332	12	32	-
● Antique Brown	542960320-23	320	332	12	32	-
● Inox Look	542960320-66	320	332	12	32	-



BIG

Design furnipart
Material Stainless Steel/Zamac

Finish	Reference	C/C	L	W	H	D
● Inox Look	224330128-66.1	128	140	-	45	22
● Inox Look	224330160-66.1	160	172	-	45	22
● Inox Look	224330192-66.1	192	204	-	45	22
● Black	224330192-9005	192	204	-	45	22
● Inox Look	224330256-66.1	256	268	-	45	22
● Black	224330256-9005	256	268	-	45	22
● Inox Look	224330320-66.1	320	332	-	45	22
● Black	224330320-9005	320	332	-	45 </td <td>22</td>	22
● Inox Look	224330448-66.1	448	460	-	45	22
● Black	224330448-9005	448	460	-	45	22



Cut-to-size - more information - page 211

● Tube	2243351200-25.1	1200	-	-	-	22
● Tube	2411301200-9005	1200	-	-	-	22
● Plastic Insert	110060.1	-	62	-	-	20
● Connector	518360012-66.1	-	12	25	45	-
● Connector	518360012-9005	-	12	25	45	-
● Foot	518365012-66.1	-	12	25	45	-
● Foot	518365012-9005	-	12	25	45	-



Model Base - page 18



Model Bounce - page 21

BOUNCE

Design Steffensen & Würtz
Material Zamac

Finish	Reference	C/C	L	W	H	D
● Inox Look	546660160-66	160	176	16	33	-
● Matt Black	546660160-99	160	176	16	33	-

*matching knob BOUNCE - page 133



BRIDGE

Design Nissen & Gehl
Material Zamac

Finish	Reference	C/C	L	W	H	D
● Inox Look	501260096-66	96	115	15	23	-
● Inox Look	501260128-66	128	145	15	26	-
● Inox Look	501260160-66	160	180	15	26	-
● Inox Look	501260224-66	224	242	15	31	-



BULL

Design furnipart
Material Zamac

Finish	Reference	C/C	L	W	H	D
● Antique Grey	528260128-22	128	139	15	33	-
● Antique Brown	528260128-23	128	139	15	33	-
● Antique Grey	528260160-22	160	170	15	33	-
● Antique Brown	528260160-23	160	170	15	33	-
● Antique Grey	528260192-22	192	203	18	38	-
● Antique Brown	528260192-23	192	203	18	38	-





Model Glove - page 43

CAR

Design furnipart
Material Zamac

Finish	Reference	C/C	L	W	H	D
● Bright Chrome	530860160-08	160	181	-	27	-
● Inox Look	530860160-66	160	181	-	27	-
● Inox Look	530860256-66	256	277	-	28	-

**CARVE**

Design Kamper Form
Material Zamac

Finish	Reference	C/C	L	W	H	D
● Matt White	552520160-0500	160	180	13	31	-
● Brushed Antracite	552520160-91	160	180	13	31	-
● Matt Black	552520160-99	160	180	13	31	-
● Matt White	552520320-0500	320	333	13	31	-
● Brushed Anthracite	552520320-91	320	333	13	31	-
● Matt Black	552520320-99	320	333	13	31	-

**CLASSIC**

Design Kamper Form
Material Zamac

Finish	Reference	C/C	L	W	H	D
● Antique Grey	536460160-22	160	186	9/18	38	-
● Antique Brown	536460160-23	160	186	9/18	38	-
● Inox Look	536460160-66	160	186	9/18	38	-
● Antique Copper	536460160-98	160	186	9/18	38	-



*matching knob CLASSIC - page 134



Model Carve - page 24

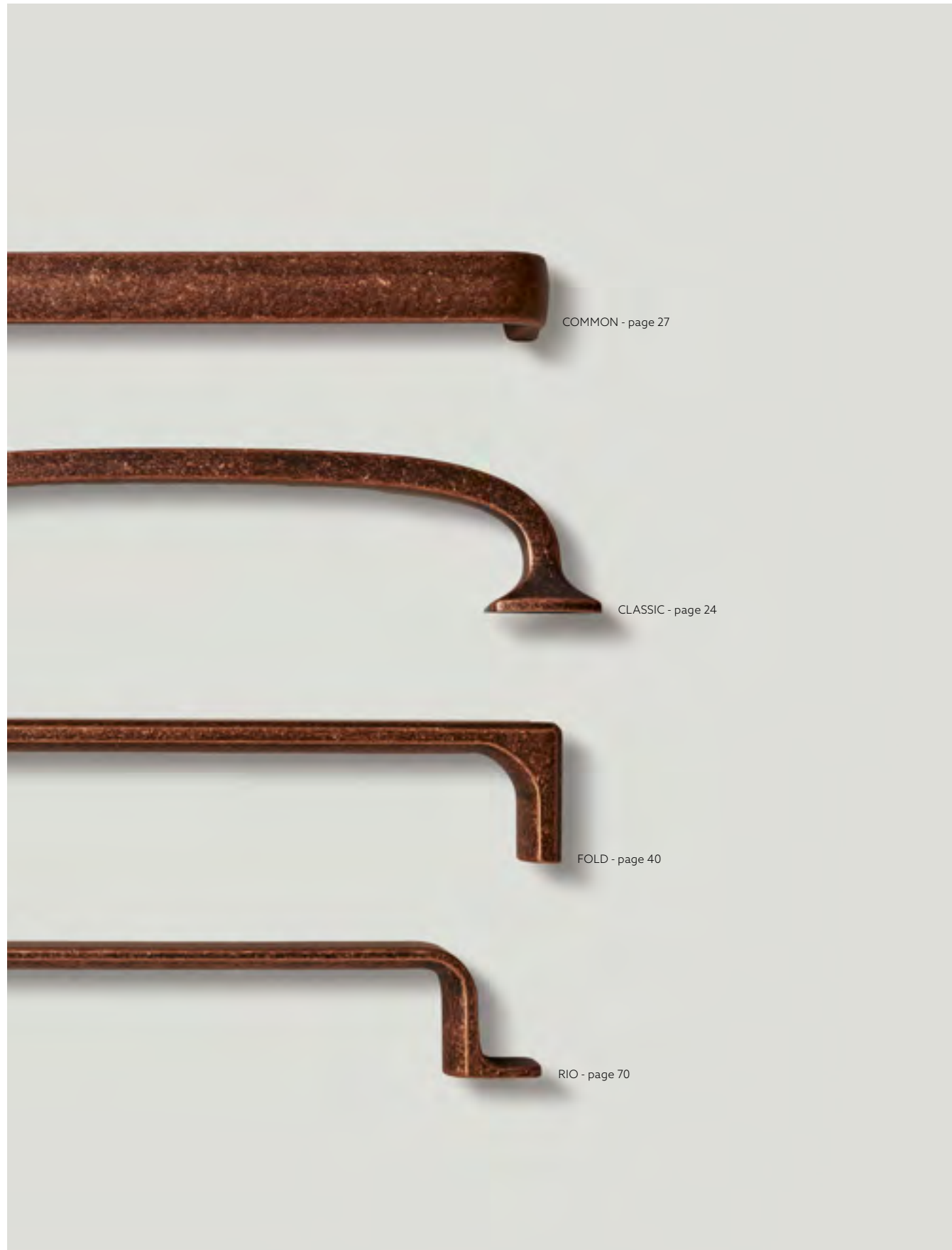

COMMON - page 27

CLASSIC - page 24

FOLD - page 40

RIO - page 70

COMMON

Design Kamper Form
Material Zamac

Finish	Reference	C/C	L	W	H	D
● Bright Chrome	535960160-08	160	170	19/16	30	-
● Inox Look	535960160-66	160	170	19/16	30	-
● Antique Copper	535960160-98	160	170	19/16	30	-



COMPACT

Design VE2
Material Zamac

Finish	Reference	C/C	L	W	H	D
● Inox Look	542860160-66	160	172	8	36	-
● Brushed Anthracite	542860160-91	160	172	8	36	-
● Matt Black	542860160-99	160	172	8	36	-
● Inox Look	542860320-66	320	332	8	36	-
● Brushed Anthracite	542860320-91	320	332	8	36	-
● Matt Black	542860320-99	320	332	8	36	-



CONCAVE

Design Hans Sandgren Jakobsen
Material Zamac

Finish	Reference	C/C	L	W	H	D
● Antique Grey	544260160-22	160	173	13	35	-
● Antique Brown	544260160-23	160	173	13	35	-
● Inox Look	544260160-66	160	173	13	35	-
● Matt Black	544260160-99	160	173	13	35	-



COOL

Design Kamper Form
Material Zamac

Finish	Reference	C/C	L	W	H	D
● Inox Look	528960192-66	192	200	16	31	-
● Inox Look	528960320-66	320	328	16	31	-

**CUBICO**

Design Designit
Material Zamac

Finish	Reference	C/C	L	W	H	D
● Antique Grey	518660096-22	96	105	15	33	-
● Inox Look	518660096-66.2	96	105	15	33	-
● Black	518660096-9005.2	96	105	15	33	-
● Bright Chrome	518660192-08	192	201	15	33	-
● Antique Grey	518660192-22	192	201	15	33	-
● Inox Look	518660192-66.2	192	201	15	33	-
● Black	518660192-9005.2	192	201	15	33	-

**CUT**

Design furnipart
Material Aluminium

Finish	Reference	C/C	L	W	H	D
● Inox Look	408220160-66	160	175	25	20	-



Model Crossing - page 31



Model D-Lite - page 31

CROSSING

Design kaschkasch
Material Wood

Finish	Reference	C/C	L	W	H	D
● FSC 100% Oak Lacq.	102990160-052	160	168	11	39	-
● FSC 100% Black Ash	102990160-992	160	168	11	39	-
● FSC 100% Oak Lacq.	102990320-052	320	328	11	39	-
● FSC 100% Black Ash	102990320-992	320	328	11	39	-



D HANDLE

Design furnipart
Material Stainless Steel

Finish	Reference	C/C	L	W	H	D
● Silk Polished	200132064-25.1	64	74	-	35	10
● Silk Polished	200132096-25.1	96	106	-	35	10
● Silk Polished	200132128-25.1	128	138	-	35	10
● Silk Polished	200132160-25.1	160	170	-	35	10
● Silk Polished	200132192-25.1	192	206	-	35	10
● Silk Polished	200132224-25.1	224	234	-	35	10
● Silk Polished	200132288-25.1	288	298	-	35	10
● Silk Polished	200132320-25.1	320	330	-	35	10
● Silk Polished	200132416-25.1	416	426	-	35	10
● Silk Polished	200132480-25.1	480	490	-	35	10
● Silk Polished	200132512-25.1	512	522	-	35	10



D-LITE

Design Adam Laws
Material Aluminium

Finish	Reference	C/C	L	W	H	D
● Bright Nickel	552120160-06	160	172	12	32	-
● Gold	552120160-34	160	172	12	32	-
● Matt Black	552120160-99	160	172	12	32	-



*matching knob D-LITE - page 138

DINER

Design Kamper Form

Material Zamac

Finish	Reference	C/C	L	W	H	D
● Inox Look	541360160-66	160	180	12	30	-
● Brushed Anthracite	541360160-91S	160	180	12	30	-
● Inox Look	541360320-66	320	340	12	30	-
● Brushed Anthracite	541360320-91S	320	340	12	30	-

**DOPPIA**

Design VE2

Material Aluminium

Finish	Reference	C/C	L	W	H	D
● Inox Look	428120128160-66	128+160	168	8	30	-
● Inox Look	428120256288-66	256+288	296	8	30	-

**ELAN**

Design VE2

Material Aluminium

Finish	Reference	C/C	L	W	H	D
● Brushed Brass	453320160-31	160	200	20	18	-
● Inox Look	453320160-66	160	200	20	18	-
● Brushed Matt Black	453320160-76	160	200	20	18	-
● Brushed Brass	453320544-31	160+544	600	20	18	-
● Inox Look	453320544-66	160+544	600	20	18	-
● Brushed Matt Black	453320544-76	160+544	600	20	18	-
● Brushed Brass	4533201088-31	160+544+1088	1200	20	18	-
● Inox Look	4533201088-66	160+544+1088	1200	20	18	-
● Brushed Matt Black	4533201088-76	160+544+1088	1200	20	18	-



*matching knob ELAN - page 141



Model Elan - page 32



Model Envelope - page 35

ELE

Design Designit
Material Zamac

Finish	Reference	C/C	L	W	H	D
● Bright Chrome	516860160192-08	160/192	260	16	25	-
● Inox Look	516860160192-66	160/192	260	16	25	-
● Bright Chrome	516860320-08	320	400	16	25	-
● Inox Look	516860320-66	320	400	16	25	-



**matching knob ELE - page 141*

ENVELOPE

Design VE2
Material Aluminium

Finish	Reference	C/C	L	W	H	D
● Brushed Brass	449220160-31	160	200	25	24	-
● Inox Look	449220160-66	160	200	25	24	-
● Brushed Matt Black	449220160-76	160	200	25	24	-

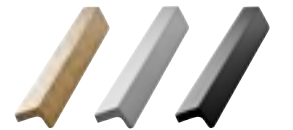

**matching knob ENVELOPE - page 141*

EPOCH LIGHT

Design Hans Sandgren Jakobsen
Material Zamac

Finish	Reference	C/C	L	W	H	D
● Inox Look	510660128-66	128	140	12	37	-
● Inox Look	510660160-66	160	172	12	37	-



EQUESTER CUP

Design Kamper Form
Material Zamac

Finish	Reference	C/C	L	W	H	D
● Bright Nickel	548420064-06	64	78	26	25	-
● Antique Brass	548420064-39	64	78	26	25	-
● Matt Black	548420064-99	64	78	26	25	-



EQUESTER

Design Kamper Form
Material Zamac

Finish	Reference	C/C	L	W	H	D
● Bright Nickel	552220160-06	160	172	12	32	-
● Antique Brass	552220160-39	160	172	12	32	-
● Matt Black	552220160-99	160	172	12	32	-
● Bright Nickel	552220320-06	320	332	12	32	-
● Antique Brass	552220320-39	320	332	12	32	-
● Matt Black	552220320-99	320	332	12	32	-



FALL

Design VE2
Material Aluminium

Finish	Reference	C/C	L	W	H	D
● Inox Look	434320128-66	128	140	20	30	-
● Brushed Matt Black	434320128-76	128	140	20	30	-
● Antique Bronze	434320128-94	128	140	20	30	-
● Inox Look	434320224-66	224	236	20	30	-
● Brushed Matt Black	434320224-76	224	236	20	30	-
● Antique Bronze	434320224-94	224	236	20	30	-

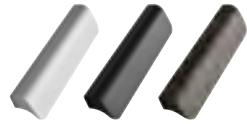

*matching knob FALL - page 144



Model Equester - page 36



Model Flat & Autumn - page 39 & 124

FLAT

Design furnipart
Material Zamac

Finish	Reference	C/C	L	W	H	D
● Bright Chrome	512860128-08	128	142	8	33	-
● Matt Chrome	512860128-09	128	142	8	33	-
● Polished Brass	512860128-29	128	142	8	33	-
● Inox Look	512860128-66	128	142	8	33	-
○ White	512860128-9010	128	142	8	33	-
● Brown Black	512860128-95	128	142	8	33	-
● Matt Black	512860128-99	128	142	8	33	-
● Bright Chrome	512860192-08	192	206	8	33	-
● Matt Chrome	512860192-09	192	206	8	33	-
● Polished Brass	512860192-29	192	206	8	33	-
● Inox Look	512860192-66	192	206	8	33	-
○ White	512860192-9010	192	206	8	33	-
● Brown Black	512860192-95	192	206	8	33	-
● Matt Black	512860192-99	192	206	8	33	-
● Bright Chrome	512860256-08	256	270	8	33	-
● Matt Chrome	512860256-09	256	270	8	33	-
● Polished Brass	512860256-29	256	270	8	33	-
● Inox Look	512860256-66	256	270	8	33	-
○ White	512860256-9010	256	270	8	33	-
● Brown Black	512860256-95	256	270	8	33	-
● Matt Black	512860256-99	256	270	8	33	-
● Bright Chrome	512860448-08	448	462	8	33	-
● Matt Chrome	512860448-09	448	462	8	33	-
● Polished Brass	512860448-29	448	462	8	33	-
● Inox Look	512860448-66	448	462	8	33	-
○ White	512860448-9010	448	462	8	33	-
● Brown Black	512860448-95	448	462	8	33	-
● Matt Black	512860448-99	448	462	8	33	-



*matching knob AUTUMN - page 124

FLUTED

Design Kamper Form
Material Zamac

Finish	Reference	C/C	L	W	H	D
● Brushed Gold	544460128-33	128	148	20	29	-
● Inox Look	544460128-66	128	148	20	29	-
● Matt Black	544460128-99	128	148	20	29	-



FOLD

Design Kamper Form
Material Zamac

Finish	Reference	C/C	L	W	H	D
● Antique Grey	537960160-22	160	170	18	32	-
● Antique Brown	537960160-23	160	170	18	32	-
● Inox Look	537960160-66	160	170	18	32	-
● Black Nickel	537960160-70	160	170	18	32	-
● Antique Copper	537960160-98	160	170	18	32	-



*matching knob FOLD - page 144

FOLD LIGHT

Design Kamper Form
Material Zamac

Finish	Reference	C/C	L	W	H	D
● Inox Look	541960160-66	160	170	13	30	-



FRAME

Design Adam Laws
Material Zamac/Acrylic

Finish	Reference	C/C	L	W	H	D
● Inox Look/Black	517760160-66/9005	160	178	12	34	-



FRINGE

Design VE2
Material Aluminium

Finish	Reference	C/C	L	W	H	D
● Brushed Brass	442220160-31	160	170	30	26	-
● Inox Look	442220160-66	160	170	30	26	-
● Brushed Matt Black	442220160-76	160	170	30	26	-
● Brushed Anthracite	442220160-91	160	170	30	26	-

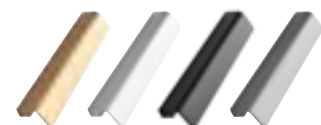

Model Fold Handle - page 40



Model Gate - page 43

GATE

Design Adam Laws
Material Zamac

Finish	Reference	C/C	L	W	H	D
● Antique Brass	549720160-39	160	172	12	30	-
● Inox Look	549720160-66	160	172	12	30	-
● Matt Black	549720160-99	160	172	12	30	-

*matching knob GATE - page 147



GLOSS

Design furnipart
Material Aluminium

Finish	Reference	C/C	L	W	H	D
● Inox Look	410230160-66-1	160	168	25	33	-
● Inox Look	410230192-66.1	192	200	25	33	-
● Inox Look	410230320-66.1	320	328	25	33	-



GLOVE

Design kaschkasch
Material Wood

Finish	Reference	C/C	L	W	H	D
● FSC 100% Oak Lacq.	103190160-052	160	180	24	26	-
● FSC 100% Black Ash	103190160-992	160	180	24	26	-

*matching knob GLOVE - page 147



GUILD

Design VE2
Material Zamac

Finish	Reference	C/C	L	W	H	D
● Brushed Anthracite	552820160-91	160	170	24	12	-
● Matt Black	552820160-99	160	170	24	12	-





HORIZON LARGE

Design Adam Laws
Material Zamac

Finish	Reference	C/C	L	W	H	D
○ Matt White	553120064-0500	64	140	70	28	-
● Matt Black	553120064-99	64	140	70	28	-

*matching knob HORIZON SMALL - page 151



HAMMER

Design Rikke Frost
Material Zamac

Finish	Reference	C/C	L	W	H	D
● Brushed Gold	544860032-33	32	160	24	16	-
● Inox Look	544860032-66	32	160	24	16	-
● Matt Black	544860032-99	32	160	24	16	-

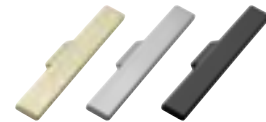

HEXA

Design Rikke Frost
Material Zamac

Finish	Reference	C/C	L	W	H	D
● Antique Brass	550520160-39	160	170	11	34	-
● Inox Look	550520160-66	160	170	11	34	-
● Matt Black	550520160-99	160	170	11	34	-

*matching knob HEXA - page 151



INSIDE

Design kaschkasch
Material Aluminium

Finish	Reference	C/C	L	W	H	D
● Inox Look	454220160-66	160	169	14	32	-
● Matt Black	454220160-99	160	169	14	32	-

*matching knob INSIDE - page 152



Model Horizon Large - page 46



Model Join - page 49

INVERT

Design Hans Sandgren Jakobsen
Material Aluminium

Finish	Reference	C/C	L	W	H	D
● Brushed Brass	445820096-31	96	120	34	23	-
● Inox Look	445820096-66	96	120	34	23	-
● Brushed Matt Black	445820096-76	96	120	34	23	-

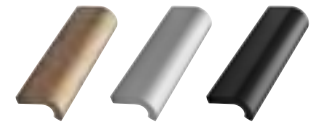

*matching knob INVERT - page 152

JOIN

Design kaschkasch
Material Wood

Finish	Reference	C/C	L	W	H	D
● FSC 100% Oak Lacq.	103290160-052	160	240	10	36	-
● FSC 100% Oak Lacq.	103290320-052	320	400	13	36	-



JUNCTION

Design Steffensen & Würtz
Material Zamac

Finish	Reference	C/C	L	W	H	D
● Brushed Brass	547060160-32	160	170	10	34	-
● Inox Look	547060160-66	160	170	10	34	-
● Brushed Anthracite	547060160-91	160	170	10	34	-
● Matt Black	547060160-99	160	170	10	34	-



LIGHT

Design furnipart
Material Aluminium

Finish	Reference	C/C	L	W	H	D
● Inox Look	428420160-66	160	176	16	25	-



LOCKER

Design furnipart
Material Zamac

Finish	Reference	C/C	L	W	H	D
● Antique Grey	534260128-22	128	140	40/13	32	-
● Antique Brown	534260128-23	128	140	40/13	32	-
● Inox Look	534260128-66	128	140	40/13	32	-



LOUNGE

Design furnipart
Material Stainless Steel / Lead Free Brass / Steel / Zamac

Finish	Reference	C/C	L	W	H	D
● Untreated Brass Polished	240330128-15	128	142	14	35	-
● Mirror Polished	240330160-18	160	174	14	35	-
● Brushed Brass	240330160-21	160	174	14	35	-
● Silk Polished	240330160-25	160	174	14	35	-
● Polished Brass	240330160-29	160	174	14	35	-
● Matt Black	546260160-99	160	174	14	35	-



LOUNGE

Design furnipart
Material Stainless Steel / Lead Free Brass / Steel / Leather

Finish	Reference	C/C	L	W	H	D
● Leather Black/Untreated Brass Polished	240330128-102/15	128	142	14	35	-
● Leather Dark Brown/Untreated Brass Polished	240330128-104/15	128	142	14	35	-
● Leather Black/Mirror Polished	240330160-102/18	160	174	14	35	-
● Leather Black/Silk Polished	240330160-102/25	160	174	14	35	-
● Leather Dark Brown/Polished Brass	240330160-104/29	160	174	14	35	-
● Leather/Steel Black Leather/Matt Black	546260160-102/99	160	174	14	35	-



Model Lounge - page 50



Model Luck - page 53

LOOP

Design furnipart
Material Aluminium

Finish	Reference	C/C	L	W	H	D
● Inox Look	411220075-66	32	75	25	16	-
● Inox Look	411220125-66	96	125	25	16	-
● Inox Look	411220225-66	128+160+192	225	25	16	-
● Inox Look	411220325-66	128+256+280	325	25	16	-
● Inox Look	411220375-66	128+330	375	25	16	-
● Inox Look	411220425-66	128+365+380	425	25	16	-
● Inox Look	411220525-66	128+448+465+480	525	25	16	-
● Inox Look	411220625-66	128+565+580	625	25	16	-
● Inox Look	411220725-66	128+665+680	725	25	16	-
● Inox Look	411220825-66	128+765+780	825	25	16	-
● Inox Look	411220925-66	128+865+880	925	25	16	-
● Inox Look	4112201125-66	128+1065+1080	1.125	25	16	-



LUCK

Design kaschkasch
Material Zamac

Finish	Reference	C/C	L	W	H	D
● Brushed Gold	544560160-33	160	179	8	40	-
● Inox Look	544560160-66	160	179	8	40	-
● Black	544560160-9005	160	179	8	40	-



*matching knob LUCK - page 155

MANGO

Design Kamper Form
Material Zamac

Finish	Reference	C/C	L	W	H	D
○ White	529060160-0502	160	172	12	35	-
● Brushed Brass	529060160-32	160	172	12	35	-
● Antique Brass	529060160-39	160	172	12	35	-
● Inox Look	529060160-66.2	160	172	12	35	-
● Grey	529060160-6000	160	172	12	35	-
● Black	529060160-9005	160	172	12	35	-
○ Bright Chrome	529060192-08	192	204	12	35	-
● Inox Look	529060192-66.2	192	204	12	35	-
● Black	529060192-9005	192	204	12	35	-
○ White	529060320-0502	320	332	12	35	-
○ Bright Chrome	529060320-08	320	332	12	35	-
● Inox Look	529060320-66.2	320	332	12	35	-
● Grey	529060320-6000	320	332	12	35	-
● Black	529060320-9005	320	332	12	35	-
● Inox Look	552420544-66	544	556	12	35	-
● Black	552420544-9005	544	556	12	35	-
● Inox Look	5524201088-66	1088	1100	12	35	-
● Black	5524201088-9005	1088	1100	12	35	-



Model Mango - page 54



Model Manor Back - page 57

MANOR

Design Kamper Form
Material Zamac

Finish	Reference	C/C	L	W	H	D
● Gold	548920128-34	128	182	14	36	14
● Antique Brass	548920128-39	128	182	14	36	14
● Matt Black	548920128-99	128	182	14	36	14
● Gold	548920192-34	192	246	14	36	14
● Antique Brass	548920192-39	192	246	14	36	14
● Matt Black	548920192-99	192	246	14	36	14



*matching knob MANOR
ROUND - page 155

MANOR BACK

Design Kamper Form
Material Zamac

Finish	Reference	C/C	L	W	H	D
● Gold	549020128-34	128	190	20	39	14
● Antique Brass	549020128-39	128	190	20	39	14
● Matt Black	549020128-99	128	190	20	39	14
● Gold	549020192-34	192	254	20	39	14
● Antique Brass	549020192-39	192	254	20	39	14
● Matt Black	549020192-99	192	254	20	39	14

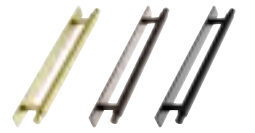

*matching knob MANOR
T - page 155

MANTA WOOD

Design Adam Laws
Material Wood

Finish	Reference	C/C	L	W	H	D
● Oak Lacq.	101390160-052	160	240	24	26	-
● Walnut Lacq.	101390160-292	160	240	24	26	-



MELON

Design Søren Holst
Material Zamac

Finish	Reference	C/C	L	W	H	D
● Inox Look	500460128-66	128	159	16	26	-
● Inox Look	500460192-66	192	229	20	33	-

**MERCURY**

Design Kamper Form
Material Zamac

Finish	Reference	C/C	L	W	H	D
● Antique Grey	536360128-22	128	146	18	32	-
● Antique Brown	536360128-23	128	146	18	32	-
● Inox Look	536360128-66	128	146	18	32	-



*matching knob MERCURY - page 155

METRO

Design Rikke Frost
Material Zamac

Finish	Reference	C/C	L	W	H	D
● Brushed Gold	540960160-33	160	180	20	28	-
● Inox Look	540960160-66	160	180	20	28	-
● Brushed Anthracite	540960160-91	160	180	20	28	-

**METRONOME**

Design Rikke Frost
Material Zamac

Finish	Reference	C/C	L	W	H	D
● Inox Look	547520160-66	160	200	19	28	-
● Matt Black	547520160-99	160	200	19	28	-



Model Metro - page 58



Model Mould - page 61

MONTE

Design VE2
Material Marble

Finish	Reference	C/C	L	W	H	D
● White	800120064-WC	64	100	28	30	-

*matching knob MONTE - page 158



MOTION

Design Steffensen & Würtz
Material Cast Iron

Finish	Reference	C/C	L	W	H	D
● Black	300080160-9005	160	182	22	35	-

*matching knob MOTION - page 158



MOULD

Design Meneghello Paoletti
Material Zamac

Finish	Reference	C/C	L	W	H	D
● Antique Grey	544760160-22.1	160	174	14	37	-
● Antique Brown	544760160-23.1	160	174	14	37	-



OAKLY

Design Hans Sandgren Jakobsen
Material Zamac

Finish	Reference	C/C	L	W	H	D
● Inox Look	531160160-66	160	224	10	39	10



OVAL

Design furnipart
Material Zamac

Finish	Reference	C/C	L	W	H	D
● Antique Black Brass	514860128-93	128	139	19/11	26	-

*matching knob OVAL - page 161



PAGODA

Design Kamper Form
Material Cast Iron

Finish	Reference	C/C	L	W	H	D
● Black	300060160-9005	160	173	13	38	-

*matching knob PAGODA - page 162



PEN

Design kaschkasch
Material Cast Iron

Finish	Reference	C/C	L	W	H	D
● Black	300070128-9005	128	183	11	32	-



PHARMA

Design furnipart
Material Zamac

Finish	Reference	C/C	L	W	H	D
● Antique Grey	534360064-22	64	95	38	22	-
● Antique Brown	534360064-23	64	95	38	22	-
● Inox Look	534360064-66	64	95	38	22	-



Model Pen - page 62



Model Port - page 65

PHONE

Design furnipart
Material Zamac

Finish	Reference	C/C	L	W	H	D
● Inox Look	531460160-66	160	178	18	35	-



PILLAR

Design Steffensen & Würtz
Material Zamac

Finish	Reference	C/C	L	W	H	D
● Antique Brass	547620160-39	160	175	15	33	-
● Inox Look	547620160-66	160	175	15	33	-
● Matt Black	547620160-99	160	175	15	33	-

*matching knob PILLAR - page 162



PORT

Design Kamper Form
Material Zamac

Finish	Reference	C/C	L	W	H	D
● Antique Grey	542760096-22	96	112	39	30	-
● Antique Brown	542760096-23	96	112	39	30	-
● Inox Look	542760096-66	96	112	39	30	-
● Matt Black	542760096-99	96	112	39	30	-

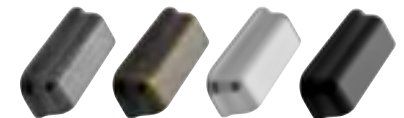

PROVENCE

Design Hans Sandgren Jakobsen
Material Cast Iron

Finish	Reference	C/C	L	W	H	D
● Black	300010160-9005	160	179	13	38	-



PRIMO SLIM

Design Adam Laws
Material Aluminium

Finish	Reference	C/C	L	W	H	D
● Inox Look	429120189-66	69	189	16	19	-
● Inox Look	429120289-66	2x84,5	289	16	19	-
● Inox Look	429120339-66	2x109,50	339	16	19	-
● Inox Look	429120389-66	2x134,5	389	16	19	-
● Inox Look	429120439-66	2x159,5	439	16	19	-
● Inox Look	429120489-66	3x123	489	16	19	-
● Inox Look	429120589-66	3x156,33	589	16	19	-
● Inox Look	429120789-66	4x167,25	789	16	19	-
● Inox Look	429120889-66	5x153,8	889	16	19	-
● Inox Look	429120989-66	6x144,83	989	16	19	-
● Inox Look	4291201089-66	6x161,5	1.089	16	19	-
● Inox Look	4291201189-66	7x152,7	1.189	16	19	-
● Black	429120289-9005	2x84,5	289	16	19	-
● Black	429120389-9005	2x134,5	389	16	19	-
● Black	429120439-9005	2x159,5	439	16	19	-
● Black	429120489-9005	3x123	489	16	19	-
● Black	429120589-9005	3x156,33	589	16	19	-
● Black	429120789-9005	4x167,25	789	16	19	-
● Black	429120889-9005	5x153,8	889	16	19	-
● Black	429120989-9005	6x144,83	989	16	19	-
● Black	4291201189-9005	7x152,7	1.189	16	19	-

**PUNCTUATE**

Design Kamper Form
Material Zamac

Finish	Reference	C/C	L	W	H	D
● Inox Look	546360160-66	160	172	12	36	-
● Brushed Anthracite	546360160-91	160	172	12	36	-
● Matt Black	546360160-99	160	172	12	36	-

**PYRAMID**

Design furnipart
Material Zamac

Finish	Reference	C/C	L	W	H	D
● Bright Chrome	518760160-08	160	173	8/16	30	-
● Inox Look	518760160-66	160	173	8/16	30	-
● Black	518760160-9005	160	173	8/16	30	-
● Bright Chrome	518760320-08	320	333	8/16	30	-
● Inox Look	518760320-66	320	333	8/16	30	-
● Black	518760320-9005	320	333	8/16	30	-



Model Primo Slim - page 66



Model Rattan - page 69

RADIUS

Design Steve McGuan
Material Zamac

Finish	Reference	C/C	L	W	H	D
● Inox Look	533860160-66	160	170	28	30	-
● Bright Chrome	533860160-08.1	160	170	28	30	-
● Bright Chrome	533860320-08.1	320	330	28	30	-



RATTAN

Design Kamper Form
Material Zamac

Finish	Reference	C/C	L	W	H	D
● Brushed Brass	549920160-32	160	168	14	31	-
● Inox Look	549920160-66	160	168	14	31	-
● Matt Black	549920160-99	160	168	14	31	-



REGULAR 2

Design Kamper Form
Material Stainless Steel

Finish	Reference	C/C	L	W	H	D
● Black	240530160-9005.2	160	174	-	40	13
● Silk Polished	240530192-25	192	206	-	40	13
● Black	240530192-9005.2	192	206	-	40	13
● Silk Polished	240530320-25	320	334	-	40	13
● Black	240530320-9005.2	320	334	-	40	13



Cut-to-size - more information - page 224

● Tube	242830800-25	-	800	-	-	13
● Tube	242830800-99	-	800	-	-	13
● Connector	553220014-66	-	14	16	40	-
● Connector	553220014-99	-	14	16	40	-
● Foot	553225014-66	-	14	16	40	-
● Foot	553225014-99	-	14	16	40	-



RHO

Design Kamper Form
Material Zamac

Finish	Reference	C/C	L	W	H	D
● Inox Look	536260160-66	160	175	18	30	-
● Inox Look	536260320-66	320	335	18	30	-



RIO

Design Kamper Form
Material Zamac

Finish	Reference	C/C	L	W	H	D
● Antique Grey	530660128-22.1	128	164	16	30	-
● Antique Brown	530660128-23.1	128	164	16	30	-
● Inox Look	530660128-66.1	128	164	16	30	-
● Antique Copper	530660128-98.1	128	164	16	30	-
● Matt Black	530660128-99.1	128	164	16	30	-
● Antique Grey	530660256-22.1	256	292	16	30	-
● Antique Brown	530660256-23.1	256	292	16	30	-
● Inox Look	530660256-66.1	256	292	16	30	-
● Matt Black	530660256-99.1	256	292	16	30	-

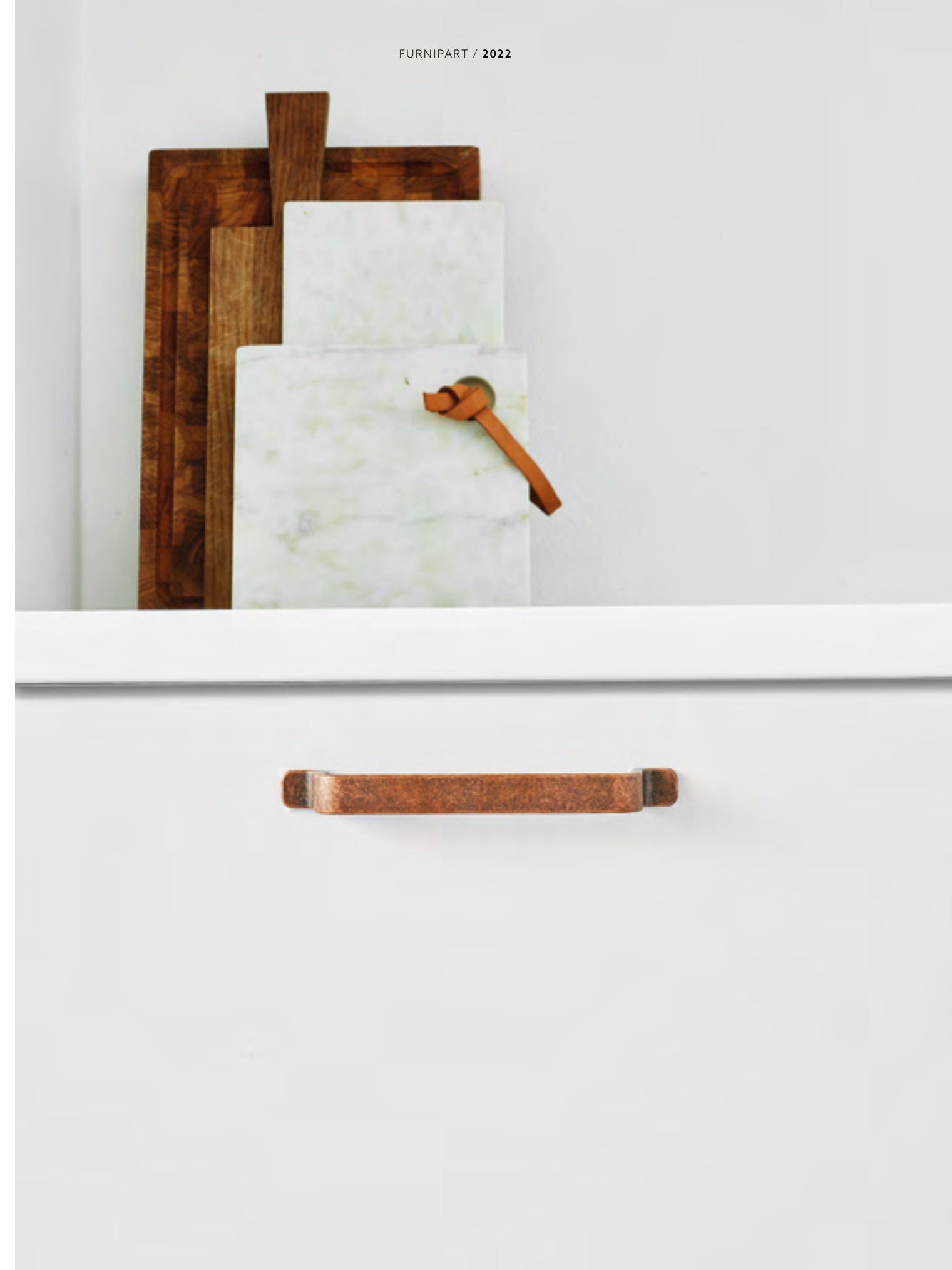
Model Rio - page 70



Model Seam - page 75



Model Scope - page 75

SAFE

Design Kamper Form
Material Aluminium

Finish	Reference	C/C	L	W	H	D
● Inox Look	437720160-66	160	169	27	27	-



SEAM

Design Kamper Form
Material Aluminium

Finish	Reference	C/C	L	W	H	D
● Bright Chrome	448920160-08	160	170	16	30	-
● Inox Look	448920160-66	160	170	16	30	-
● Black	448920160-9005	160	170	16	30	-
● Bright Chrome	448920320-08	320	330	16	30	-
● Inox Look	448920320-66	320	330	16	30	-
● Black	448920320-9005	320	330	16	30	-



SCOPE

Design Rikke Frost
Material Zamac

Finish	Reference	C/C	L	W	H	D
● Inox Look	543060160-66	160	176	16	36	-
● Black	543060160-9005	160	176	16	36	-

*matching knob SCOPE - page 165



SHIP

Design furnipart
Material Zamac

Finish	Reference	C/C	L	W	H	D
● Antique Grey	529660128-22	128	165	25	37	-
● Antique Brown	529660128-23	128	165	25	37	-
● Inox Look	529660128-66.1	128	165	25	37	-



SHUFFLE

Design Meneghello Paoelli

Material Zamac

Finish	Reference	C/C	L	W	H	D
● Brushed Gold	543160160-33	160	172	12	37	-
● Inox Look	543160160-66	160	172	12	37	-
● Brushed Anthracite	543160160-91	160	172	12	37	-

**SLIM**

Design Meike Neuhaus

Material Zamac

Finish	Reference	C/C	L	W	H	D
● Bright Chrome	515460160-08.2	160	200	8/11	30	-
● Inox Look	515460160-66.2	160	200	8/11	30	-
● Matt Black	515460160-99	160	200	8/11	30	-
● Bright Chrome	515460320-08.2	320	360	8/11	30	-
● Inox Look	515460320-66.2	320	360	8/11	30	-
● Matt Black	515460320-99	320	360	8/11	30	-
● Bright Chrome	515460448-08.2	448	488	8/11	30	-
● Inox Look	515460448-66.2	448	488	8/11	30	-
● Matt Black	515460448-99	448	488	8/11	30	-



Model Slim - page 76



Model Slope - page 79

SLOPE

Design kaschkasch
Material Zamac

Finish	Reference	C/C	L	W	H	D
● Inox Look	550320160-66	160	181	25	31	-
● Matt Black	550320160-99	160	181	25	31	-

*matching knob SLOPE - page 166

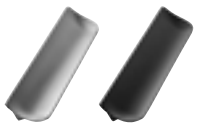

SPAN

Design Meike Neuhaus
Material Aluminium

Finish	Reference	C/C	L	W	H	D
● Bright Chrome	449020160-08	160	171	15	33	-
● Inox Look	449020160-66	160	171	15	33	-
● Black	449020160-9005	160	171	15	33	-



SQUARE 10 OCEANIX

Design furnipart
Material Reused Ocean Plastic Tumbled

Finish	Reference	C/C	L	W	H	D
● Dyed Black	700020128-86	128	138	10	32	-

*matching knob PLATO OCEANIX - page 162



SQUARE 10

Design furnipart
Material Aluminium

Finish	Reference	C/C	L	W	H	D
○ Matt White	435820128-0500	128	138	10	32	-
● Brushed Brass	435820128-31	128	138	10	32	-
● Inox Look	435820128-66	128	138	10	32	-
● Brushed Matt Black	435820128-76	128	138	10	32	-
● Brushed Anthracite	435820128-91	128	138	10	32	-

*matching knob PLATO - page 162



SQUARE 10

Design furnipart

Material Cast aluminium

Finish	Reference	C/C	L	W	H	D
● Inox Look	414620096-66	96	106	10	32	-
● Inox Look	414620128-66	128	138	10	32	-
● Inox Look	414620192-66	192	202	10	32	-
● Inox Look	414620224-66	224	234	10	32	-
● Inox Look	414620320-66	320	330	10	32	-
● Inox Look	414620448-66	448	458	10	32	-
● Black	414620096-66	96	106	10	32	-
● Black	414620128-66	128	138	10	32	-
● Black	414620192-66	192	202	10	32	-
● Black	414620224-66	224	234	10	32	-
● Black	414620320-66	320	330	10	32	-
● Black	414620448-66	448	458	10	32	-

**SQUARE 10**

Design furnipart

Material Zamac

Finish	Reference	C/C	L	W	H	D
● Bright Chrome	510360096/08	96	106	10	32	-
● Matt Chrome	510360096/09	96	106	10	32	-
● Inox Look	510360096/66	96	106	10	32	-
● Bright Chrome	510360128/08	128	138	10	32	-
● Matt Chrome	510360128/09	128	138	10	32	-
● Inox Look	510360128/66	128	138	10	32	-
● Matt Black	510360128/99	128	138	10	32	-
● Bright Chrome	510360160/08	160	170	10	32	-
● Matt Chrome	510360160/09	160	170	10	32	-
● Inox Look	510360160/66	160	170	10	32	-
● Matt Black	510360160/99	160	170	10	32	-
● Bright Chrome	510360192/08	192	202	10	32	-
● Matt Chrome	510360192/09	192	202	10	32	-
● Inox Look	510360192/66	192	202	10	32	-
● Bright Chrome	510360224/08	224	234	10	32	-
● Matt Chrome	510360224/09	224	234	10	32	-
● Inox Look	510360224/66	224	234	10	32	-
● Matt Black	510360224/99	224	234	10	32	-
● Bright Chrome	510360320/08	320	330	10	32	-
● Matt Chrome	510360320/09	320	330	10	32	-
● Inox Look	510360320/66	320	330	10	32	-
● Matt Black	510360320/99	320	330	10	32	-
● Bright Chrome	510360448/08	448	458	10	32	-
● Matt Chrome	510360448/09	448	458	10	32	-
● Inox Look	510360448/66	448	458	10	32	-
● Matt Black	510360448/99	448	458	10	32	-



Model Square 10 - page 80



Model Station - page 83

SQUARE 12

Design furnipart
Material Zamac

Finish	Reference	C/C	L	W	H	D
● Inox Look	509560160/66	160	172	12	32	-
● Inox Look	509560224/66	224	236	12	32	-



SQUARE 12

Design furnipart
Material Aluminium

Finish	Reference	C/C	L	W	H	D
● Black	413020160-9005	160	172	12	32	-
● Black	413020192-9005	192	204	12	32	-
● Black	413020320-9005	320	332	12	32	-



SQUARE 14

Design furnipart
Material Stainless Steel

Finish	Reference	C/C	L	W	H	D
● Silk Polished	231037160-25	160	174	14	42	-
● Silk Polished	231037192-25	192	206	14	42	-
● Silk Polished	231037224-25	224	238	14	42	-
● Silk Polished	231037320-25	320	334	14	42	-
● Silk Polished	231037448-25	448	462	14	42	-
● Silk Polished	231037512-25	512	526	14	42	-



STATION

Design Kamper Form
Material Aluminium

Finish	Reference	C/C	L	W	H	D
● Brushed Brass	437620160-31	160	190	22	25	-
● Inox Look	437620160-66	160	190	22	25	-
● Brushed Matt Black	437620160-76	160	190	22	25	-
● Brushed Brass	437620320-31	320	350	22	25	-
● Inox Look	437620320-66	320	350	22	25	-
● Brushed Matt Black	437620320-76	320	350	22	25	-

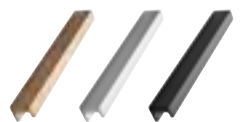

*matching knob STATION - page 169

STREAMLINE

Design Adam Laws
Material Aluminium

Finish	Reference	C/C	L	W	H	D
● Black	454520096-9005	96	225	17	17	-
● Black	454520256-9005	256	385	17	17	-



TANGERINE

Design Adam Laws
Material Aluminium

Finish	Reference	C/C	L	W	H	D
● Inox Look	427920128-66	128	146	16/7	27	-



TAU

Design VE2
Material Aluminium

Finish	Reference	C/C	L	W	H	D
● Brushed Brass	446320160-31	160	286	10	25	-
● Inox Look	446320160-66	160	286	10	25	-
● Brushed Matt Black	446320160-76	160	286	10	25	-
● Brushed Anthracite	446320160-91	160	286	10	25	-



*matching knob TAU - page 169



Model Streamline - page 84



Model Trail - page 87

TORCH

Design Rikke Frost
Material Zamac

Finish	Reference	C/C	L	W	H	D
● Inox Look	546560160-66	160	177	13	37	-
● Brushed Anthracite	546560160-91	160	177	13	37	-
● Matt Black	546560160-99	160	177	13	37	-



TRAIL

Design Kamper Form
Material Zamac

Finish	Reference	C/C	L	W	H	D
● Antique Brown	538760128-23	128	154	19/14	32	-
● Inox Look	538760128-66	128	154	19/14	32	-

*matching knob TRAIL - page 170



TRANSIT

Design VE2
Material Zamac

Finish	Reference	C/C	L	W	H	D
● Inox Look	550620160-66	160	219	12	24	-
● Matt Black	550620160-99	160	219	12	24	-

*matching knob TRANSIT - page 170



TUBULAR

Design furnipart

Material Lead Free Brass

Finish	Reference	C/C	L	W	H	D
● Untreated Brass	242330096-15	96	105	9	36	-
● Untreated Brass	242330128-15	128	137	9	36	-



TWIRL

Design Meneghello Paoelli

Material Zamac

Finish	Reference	C/C	L	W	H	D
● Brushed Gold	544660160-33	160	172	12	36	-
● Inox Look	544660160-66	160	172	12	36	-
● Brushed Anthracite	544660160-91	160	172	12	36	-
● Matt Black	544660160-99	160	172	12	36	-



U-TURN

Design Hans Sandgren Jakobsen

Material Zamac

Finish	Reference	C/C	L	W	H	D
● Antique Grey	540760160-22	160	187	7	38	-
● Antique Brown	540760160-23	160	187	7	38	-
● Inox Look	540760160-66	160	187	7	38	-
● Matt Black	540760160-99	160	187	7	38	-

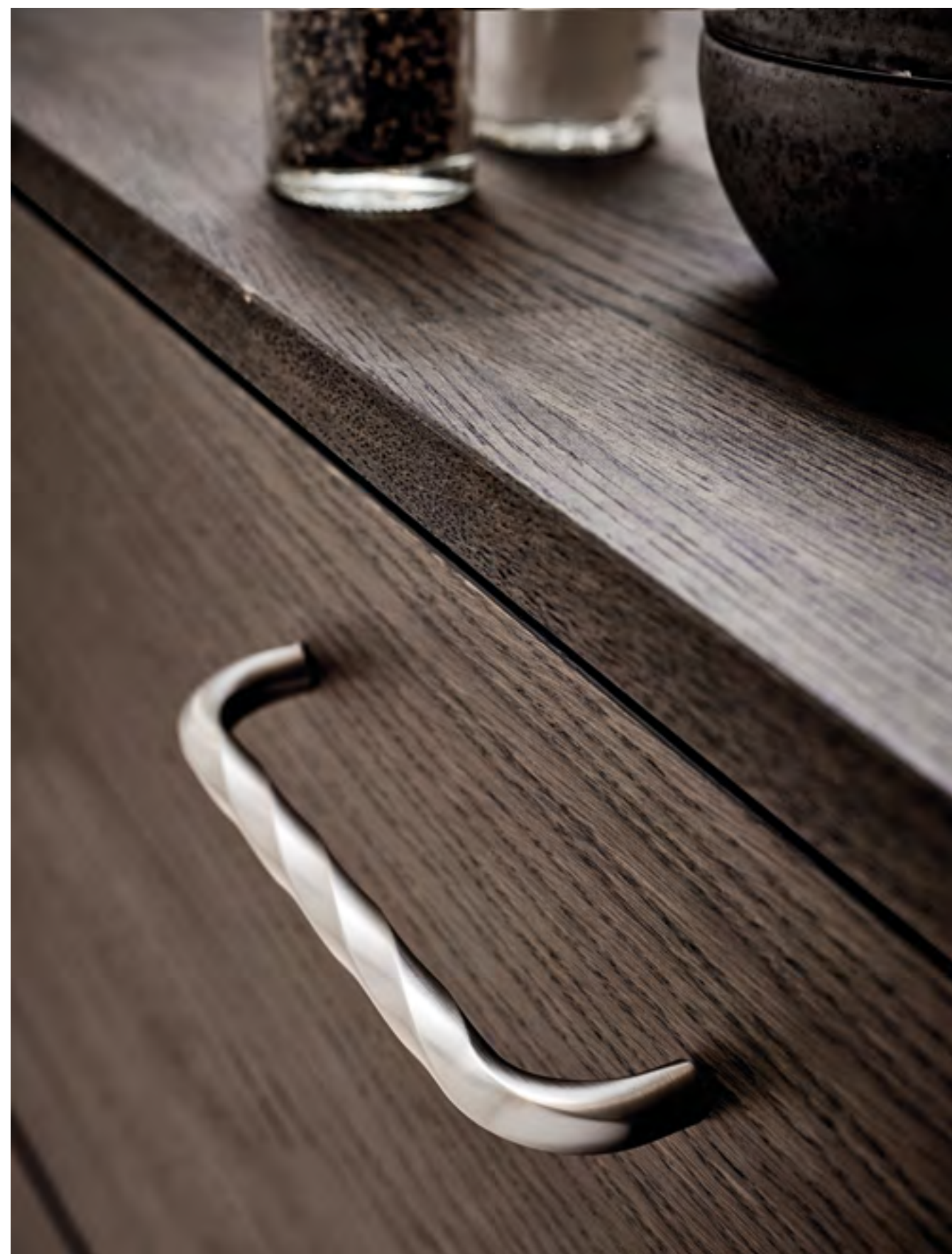
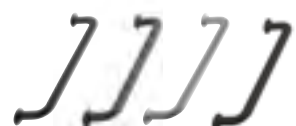

Model Twirl - page 88



Model Villa - page 91

VANILLA

Design Kamper Form
Material Ceramic

Finish	Reference	C/C	L	W	H	D
○ White	601201096-0	96	140	30	26	-

**matching knob VANILLA - page 170*



VILLA

Design Kamper Form
Material Zamac

Finish	Reference	C/C	L	W	H	D
● Bright Nickel	553020128-06	128	177	20	34	-
● Black Nickel	553020128-70	128	177	20	34	-
● Bright Nickel	553020192-06	192	241	20	34	-
● Black Nickel	553020192-70	192	241	20	34	-

**matching knob VILLA ROUND - page 173*



VISTA

Design Kamper Form

Material Zamac

Finish	Reference	C/C	L	W	H	D
● Inox Look	538560096-66	96	112	10	38	-
● Bright Chrome	538560160-08	160	176	10	38	-
● Inox Look	538560160-66	160	176	10	38	-
● Brushed Anthracite	538560160-91	160	176	10	38	-
● Inox Look	532960192-66	192	208	10	38	-
● Bright Chrome	538560256-08	256	272	10	38	-
● Inox Look	538560256-66	256	272	10	38	-
● Bright Chrome	538560320-08	320	336	10	38	-
● Inox Look	538560320-66	320	336	10	38	-
● Brushed Anthracite	538560320-91	320	336	10	38	-

**WAFER**

Design Kamper Form

Material Zamac

Finish	Reference	C/C	L	W	H	D
● Antique Grey	546460160-22	160	172	18	32	-
● Antique Brown	546460160-23	160	172	18	32	-
● Inox Look	546460160-66	160	172	18	32	-
● Matt Black	546460160-99	160	172	18	32	-

**WRAP**

Design Adam Laws

Material Zamac

Finish	Reference	C/C	L	W	H	D
● Inox Look	533660128-66	128	190	27	20	-



Model Vista - page 92

CRADLE TO CRADLE

All our chrome and anodised aluminium profiles have been certified to bronze level under the Cradle to Cradle Certified® Product Standard since 2018. The assessment procedure is carried out by the Danish assessor Vugge til Vugge ApS. As a part of the assessment, inspectors visit our production facilities to evaluate and document the sustainability of our products. The Cradle to Cradle Certified® Product Standard is based on stringent screening requirements, and every step in our process to manufacture aluminium profiles has been thoroughly examined and documented.

Furthermore, as of March 2022, all Zamac products from our catalogue in finish 66, 99 and 9005 produced at our main production sites will also be certified according to the Cradle to Cradle Certified® Product Standard.





The Cradle to Cradle Certified® Product Standard adopts a different perspective on design and production. Instead of following the traditional view that products should be sustainable from cradle to grave, the new approach rates products according to the extent to which they can be safely assimilated into new life cycles when they no longer fulfil their original purpose. This is why we are particularly pleased to have been awarded this certification. In the long term, we are committed to making a contribution that is actively positive – rather than simply “less negative”.





DECORATIVE ALUMINUM PROFILES FOR CABINETS
 Furnipart AS
 Version 3.1
 Renewal 11 Oct 2022

BRONZE BASIC **BRONZE** SILVER GOLD PLATINUM

	MATERIAL HEALTH	✓
	MATERIAL REUTILIZATION	✓
	RENEWABLE ENERGY	✓
	WATER STEWARDSHIP	✓
	SOCIAL FAIRNESS	✓

The following parameters have been assessed and given a score (from Bronze to Platinum):

Material Health

- All chemicals have been assessed according to how they influence both humans and the environment. The aim is to make the products as safe as possible for both
 - Bronze

Material Reutilization

- Our products' ability to re-enter new product life cycles have been assessed. The aim is to eliminate waste and have products entering perpetual cycles instead
 - Gold

Renewable Energy & Carbon Management

- Vugge til Vugge ApS have looked at the extent to which we use renewable energy at our productions to either reduce or ideally eliminate the impact of climate changing greenhouse gases
 - Gold

Water Stewardship

- The quality of effluent has been assessed through a facility-wide water audit. The aim is to have effluent with drinking water quality
 - Silver

Social Fairness

- Our ability to live up to known standards for social responsibility has been assessed. The aim is to ensure good working conditions at our productions and all parts of the supply chain
 - Gold

PROFILE REAR MOUNTED



ACCENT

Design Steffensen & Würtz
Material Aluminium

Finish	Reference	C/C	L	W	H	D
● Brushed Brass	446820050-31	32	50	45	16	-
● Inox Look	446820050-66	32	50	45	16	-
● Matt Black	446820050-76	32	50	45	16	-
● Brushed Brass	446820200-31	160	200	45	16	-
● Inox Look	446820200-66	160	200	45	16	-
● Matt Black	446820200-76	160	200	45	16	-

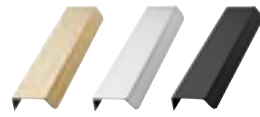
**ARTISAN**

Design VE2
Material Aluminium

Finish	Reference	C/C	L	W	H	D
● Brushed Brass	454320040-31	20	40	41	12	-
● Inox Look	454320040-66	20	40	41	12	-
● Brushed Matt Black	454320040-76	20	40	41	12	-
● Brushed Brass	454320200-31	160	200	41	12	-
● Inox Look	454320200-66	160	200	41	12	-
● Brushed Matt Black	454320200-76	160	200	41	12	-

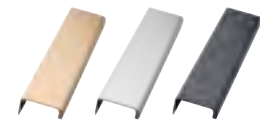

Model Artisan - page 100



BENCH

Design Adam Laws
Material Aluminium

Finish	Reference	C/C	L	W	H	D
● Brushed Brass	442320040-31	20	40	48	19	-
● Inox Look	442320040-66	20	40	48	19	-
● Brushed Matt Black	442320040-76	20	40	48	19	-
● Brushed Rose Gold	442320040-87	20	40	48	19	-
● Brushed Brass	442320100-31	60	100	48	19	-
● Inox Look	442320100-66	60	100	48	19	-
● Brushed Matt Black	442320100-76	60	100	48	19	-
● Brushed Brass	442320200-31	2x80	200	48	19	-
● Inox Look	442320200-66	2x80	200	48	19	-
● Brushed Matt Black	442320200-76	2x80	200	48	19	-
● Brushed Rose Gold	442320200-87	2x80	200	48	19	-

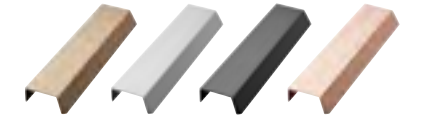

Model Bench - page 103

BLAZE 2

Design Meneghello Paoelli

Material Aluminium

Finish	Reference	C/C	L	W	H	D
● Brushed Brass	434520060-31	20	60	40	18	-
● Inox Look	434520060-66	20	60	40	18	-
● Brushed Matt Black	434520060-76	20	60	40	18	-
● Brushed Anthracite	434520060-91	20	60	40	18	-
● Brushed Brass	434520200-31	2x80	200	40	18	-
● Inox Look	434520200-66	2x80	200	40	18	-
● Brushed Matt Black	434520200-76	2x80	200	40	18	-
● Brushed Anthracite	434520200-91	2x80	200	40	18	-
● Brushed Brass	434520350-31	2x160	350	40	18	-
● Inox Look	434520350-66	2x160	350	40	18	-
● Brushed Matt Black	434520350-76	2x160	350	40	18	-
● Brushed Anthracite	434520350-91	2x160	350	40	18	-

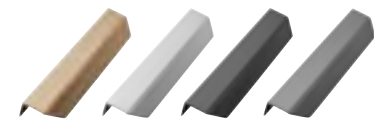

Model Blaze 2 - page 104



Model Edge Filigree - page 107

EDGE BOW

Design Adam Laws
Material Aluminium

Finish	Reference	C/C	L	W	H	D
● Bright Chrome	423920200-08.1	160	200	41	18	-
● Inox Look	423920200-66.1	160	200	41	18	-
● Bright Chrome	423920350-08.1	2x160	350	41	18	-
● Inox Look	423920350-66.1	2x160	350	41	18	-



EDGE FILIGREE

Design Rikke Frost
Material Aluminium



Finish	Reference	C/C	L	W	H	D
● Inox Look	434020060-66	20	60	45	21	-
● Brushed Anthracite	434020060-91	20	60	45	21	-
● Antique Bronze	434020060-94	20	60	45	21	-
● Inox Look	434020176-66	80	176	45	21	-
● Brushed Anthracite	434020176-91	80	176	45	21	-
● Antique Bronze	434020176-94	80	176	45	21	-



EDGE ROUND

Design Adam Laws
Material Aluminium

Finish	Reference	C/C	L	W	H	D
● Inox Look	419920040-66	20	40	41	18	-
● Inox Look	419920200-66	2x80	200	41	18	-
● Inox Look	419920350-66	2x160	350	41	18	-



EDGE STRAIGHT

Design Adam Laws
Material Aluminium

Finish	Reference	C/C	L	W	H	D
● Matt White	419720040-0500	20	40	41	18	-
● White w/structure	419720040-S0501	20	40	41	18	-
○ White	419720040-9010.1	20	40	41	18	-
● Beige	419720040-S2005	20	40	41	18	-
● Dune grey w/structure	419720040-S2501	20	40	41	18	-
● Grey	419720040-S5000	20	40	41	18	-
● Taupe w/structure	419720040-S5501	20	40	41	18	-
● Foliage green w/structure	419720040-S6011	20	40	41	18	-
● Anthracite	419720040-S8000	20	40	41	18	-
● Midnight blue w/structure	419720040-S8011	20	40	41	18	-
● Black w/structure	419720040-S8501	20	40	41	18	-
● Matt White	419720100-0500	60	100	41	18	-
○ White	419720100-9010.1	60	100	41	18	-
● Grey	419720100-S5000	60	100	41	18	-
● Anthracite	419720100-S8000	60	100	41	18	-
● Matt White	419720200-0500	2x80	200	41	18	-
● White w/structure	419720200-S0501	2x80	200	41	18	-
○ White	419720200-9010.1	2x80	200	41	18	-
● Beige	419720200-S2005	2x80	200	41	18	-
● Dune grey w/structure	419720200-S2501	2x80	200	41	18	-
● Grey	419720200-S5000	2x80	200	41	18	-
● Taupe w/structure	419720200-S5501	2x80	200	41	18	-
● Foliage green w/structure	419720200-S6011	2x80	200	41	18	-
● Anthracite	419720200-S8000	2x80	200	41	18	-
● Midnight blue w/structure	419720200-S8011	2x80	200	41	18	-
● Black w/structure	419720200-S8501	2x80	200	41	18	-
● Matt White	419720350-0500	2x160	350	41	18	-
○ White	419720350-9010.1	2x160	350	41	18	-
● Beige	419720350-S2005	2x160	350	41	18	-
● Grey	419720350-S5000	2x160	350	41	18	-
● Anthracite	419720350-S8000	2x160	350	41	18	-
● Matt White	419720600-0500	3x160	600	41	18	-
● Matt White	4197201200-0500	7x160	1200	41	18	-



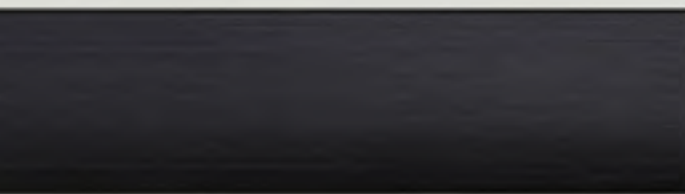

FINISH 76.1



FINISH 91.1



FINISH 94



FINISH 39.1

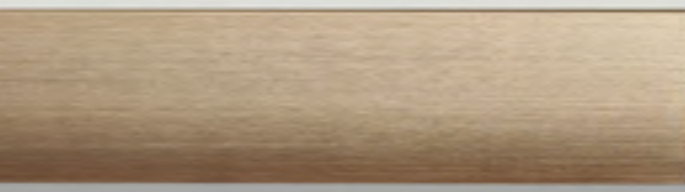

FINISH 31.1



FINISH 87.1



FINISH 66.1

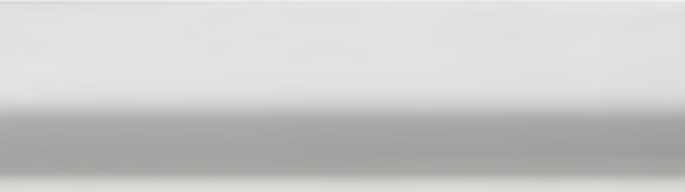

FINISH 12.1



FINISH 08.1

EDGE STRAIGHT

Design Adam Laws
Material Aluminium

Finish	Reference	C/C	L	W	H	D
● Bright Chrome	419720040-08.1	20	40	41	18	-
● Bright Anodized	419720040-12.1	20	40	41	18	-
● Brass Brushed	419720040-31.1	20	40	41	18	-
● Antique Brass	419720040-39.1	20	40	41	18	-
● Inox Look	419720040-66.1	20	40	41	18	-
● Brushed Matt Black	419720040-76.1	20	40	41	18	-
● Brushed Rose Gold	419720040-87.1	20	40	41	18	-
● Brushed Anthracite	419720040-91.1	20	40	41	18	-
● Antique Bronze	419720040-94	20	40	41	18	-
● Brass Brushed	419720100-31.1	60	100	41	18	-
● Antique Brass	419720100-39.1	60	100	41	18	-
● Inox Look	419720100-66.1	60	100	41	18	-
● Brushed Matt Black	419720100-76.1	60	100	41	18	-
● Brushed Rose Gold	419720100-87.1	60	100	41	18	-
● Brushed Anthracite	419720100-91.1	60	100	41	18	-
● Bright Chrome	419720200-08.1	2x80	200	41	18	-
● Bright Anodized	419720200-12.1	2x80	200	41	18	-
● Brass Brushed	419720200-31.1	2x80	200	41	18	-
● Antique Brass	419720200-39.1	2x80	200	41	18	-
● Inox Look	419720200-66.1	2x80	200	41	18	-
● Brushed Matt Black	419720200-76.1	2x80	200	41	18	-
● Brushed Rose Gold	419720200-87.1	2x80	200	41	18	-
● Brushed Anthracite	419720200-91.1	2x80	200	41	18	-
● Antique Bronze	419720200-94	2x80	200	41	18	-
● Bright Chrome	419720350-08.1	2x160	350	41	18	-
● Bright Anodized	419720350-12.1	2x160	350	41	18	-
● Brass Brushed	419720350-31.1	2x160	350	41	18	-
● Antique Brass	419720350-39.1	2x160	350	41	18	-
● Inox Look	419720350-66.1	2x160	350	41	18	-
● Brushed Matt Black	419720350-76.1	2x160	350	41	18	-
● Brushed Rose Gold	419720350-87.1	2x160	350	41	18	-
● Brushed Anthracite	419720350-91.1	2x160	350	41	18	-
● Antique Bronze	419720350-94	2x160	350	41	18	-
● Brass Brushed	419720600-31.1	3x160	600	41	18	-
● Inox Look	419720600-66.1	3x160	600	41	18	-
● Brushed Matt Black	419720600-76.1	3x160	600	41	18	-
● Brass Brushed	4197201200-31.1	7x160	1200	41	18	-
● Inox Look	4197201200-66.1	7x160	1200	41	18	-
● Brushed Matt Black	4197201200-76.1	7x160	1200	41	18	-

EDGE STRAIGHT UPWARDS

Design furnipart
Material Aluminium

Finish	Reference	C/C	L	W	H	D
● Inox Look	435920040-66	20	40	41	-	-

EDGE URBAN

Design Adam Laws
Material Aluminium

Finish	Reference	C/C	L	W	H	D
● Inox Look	419820200-66	2x32	200	41	18	-
● Inox Look	419820350-66	2x64	350	41	18	-

PATINA

Design furnipart
Material Lead Free Brass

Finish	Reference	C/C	L	W	H	D
● Untreated Brass	242430045-15	30	45	40	19	-
● Untreated Brass	242430120-15	96	120	40	19	-

PLINTH

Design furnipart
Material Stainless Steel

Finish	Reference	C/C	L	W	H	D
● Silk Polished	229030096-25.1	96	120	40	20	-
● Silk Polished	229030128-25.1	128	160	45	25	-





Model Patina - page 112

SHEET

Design kaschkasch
Material Aluminium

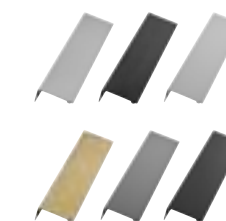
Finish	Reference	C/C	L	W	H	D
● Brushed Brass	446620060-31	32	60	45	21	-
● Inox Look	446620060-66	32	60	45	21	-
● Matt Black	446620060-76	32	60	45	21	-
● Beige	446620060-S2005	32	60	45	21	-
● Grey	446620060-S5000	32	60	45	21	-
● Anthracite	446620060-S8000	32	60	45	21	-
● Brushed Brass	446620200-31	160	200	45	21	-
● Inox Look	446620200-66	160	200	45	21	-
● Matt Black	446620200-76	160	200	45	21	-
● Beige	446620200-S2005	160	200	45	21	-
● Grey	446620200-S5000	160	200	45	21	-
● Anthracite	446620200-S8000	160	200	45	21	-

**WOW**

Design furnipart
Material Zamac

Finish	Reference	C/C	L	W	H	D
● Bright Chrome	534660064-08	64	96	42	20	-
● Inox Look	534660064-66	64	96	42	20	-
● Bright Chrome	534660160-08	160	192	42	20	-
● Inox Look	534660160-66	160	192	42	20	-
● Bright Chrome	534660256-08	256	320	42	20	-
● Inox Look	534660256-66	256	320	42	20	-

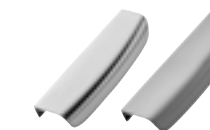

SUSTAINABILITY

It was in 2018 that furnipart took its journey towards more sustainable production to a whole new level. Thus far, this journey has resulted in a to Cradle to Cradle Certified® Product Standard for our existing range, and it has lead onto new and exciting prospects using an innovative material. We are well aware that our knobs and handles alone cannot save the world, but we are taking small steps in the right direction and proving to ourselves and to the industry in general that there are different ways of doing things. The results that we achieve as our journey progresses lay the foundations for other sustainable initiatives that can help us and the industry as a whole to understand how to generate as little environmental impact as possible. Through our business procedures, we are committed to demonstrating that sustainability can easily become a natural part of a visionary enterprise. Not because it boosts turnover, but because it is quite simply the right thing to do.

OCEANIX/ Plato & Square

The two attractive handles – Plato and Square – made of recycled plastic can trace their roots back to a location other than furnipart, so come with us on a trip to West Jutland, Denmark. Based in the Danish town of Lemvig, PLASTIX is a small company that has developed trail-blazing technology which makes it possible to re-use plastic from abandoned fishing nets, for example, and from other plastic material used in the maritime industry. The oceans of the world are experiencing a growing problem in the form of nets, trawls and other plastic material that is simply dumped in the water.



Model Square OceanIX 10 - page 79



Model Plato OceanIX - page 162

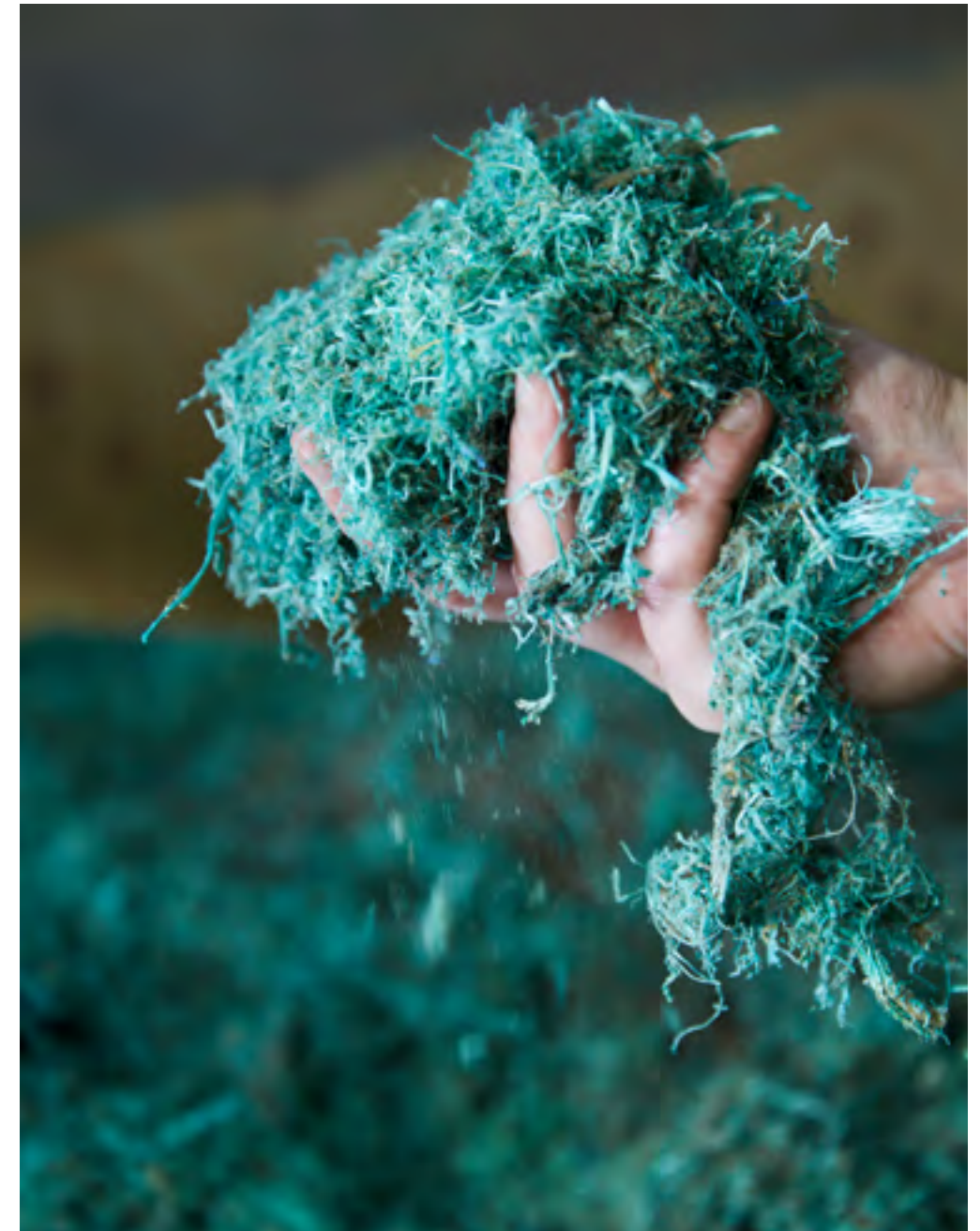

OceanIX

KNOBS

AUTUMN

Design VE2
Material Zamac

Finish	Reference	C/C	L	W	H	D
● Bright Chrome	541060028-08	-	-	-	27	28
● Brushed Brass	541060028-29	-	-	-	27	28
● Inox Look	541060028-66	-	-	-	27	28
○ White	541060028-9010	-	-	-	27	28
● Brushed Anthracite	541060028-91	-	-	-	27	28
● Matt Black	541060028-99	-	-	-	27	28
● Bright Chrome	541060036-08	-	-	-	34	36
● Inox Look	541060036-66	-	-	-	34	36
● Matt Black	541060036-99	-	-	-	34	36

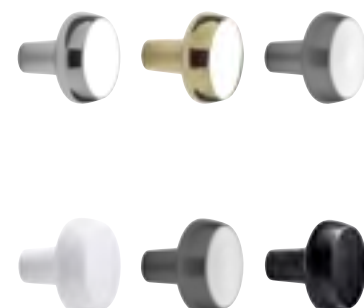

*matching handle FLAT - page 39

BALANCE

Design VE2
Material Zamac

Finish	Reference	C/C	L	W	H	D
● Inox Look	546860090-66	-	90	18	37	-
● Matt Black	546860090-99	-	90	18	37	-



BANISTER

Design furnipart
Material Zamac

Finish	Reference	C/C	L	W	H	D
● Antique Brown	533960033-23	-	-	-	43	33
● Inox Look	533960033-66	-	-	-	43	33



Model Balance - page 124





Model Bell - page 127

BEAD STRAIGHT

Design VE2

Material Stainless Steel / Marble





Finish	Reference	C/C	L	W	H	D
 Green	242035028-25/GM	-	-	-	35	28
 White	242035028-25/WC	-	-	-	35	28



BELL

Design Hans Sandgren Jakobsen

Material Zamac

Finish	Reference	C/C	L	W	H	D
 Antique Grey	540860042-22	-	-	-	32	42
 Antique Brown	540860042-23	-	-	-	32	42
 Inox Look	540860042-66	-	-	-	32	42
 Matt Black	540860042-99	-	-	-	32	42



BERET

Design kaschkasch
Material Wood

Finish	Reference	C/C	L	W	H	D
● FSC 100% Oak Lacq.	10289004-052	-	-	-	21	45
● FSC 100% Black Ash	10289004-992	-	-	-	21	45

**BLOCK**

Design furnipart
Material Zamac

Finish	Reference	C/C	L	W	H	D
● Inox Look	512760045-66	16	45	45	34	-
● Matt Black	512760045-99	16	45	45	34	-

**BOBBIN**

Design furnipart
Material Steel

Finish	Reference	C/C	L	W	H	D
● Inox Look	208610025-25	-	-	-	24	25

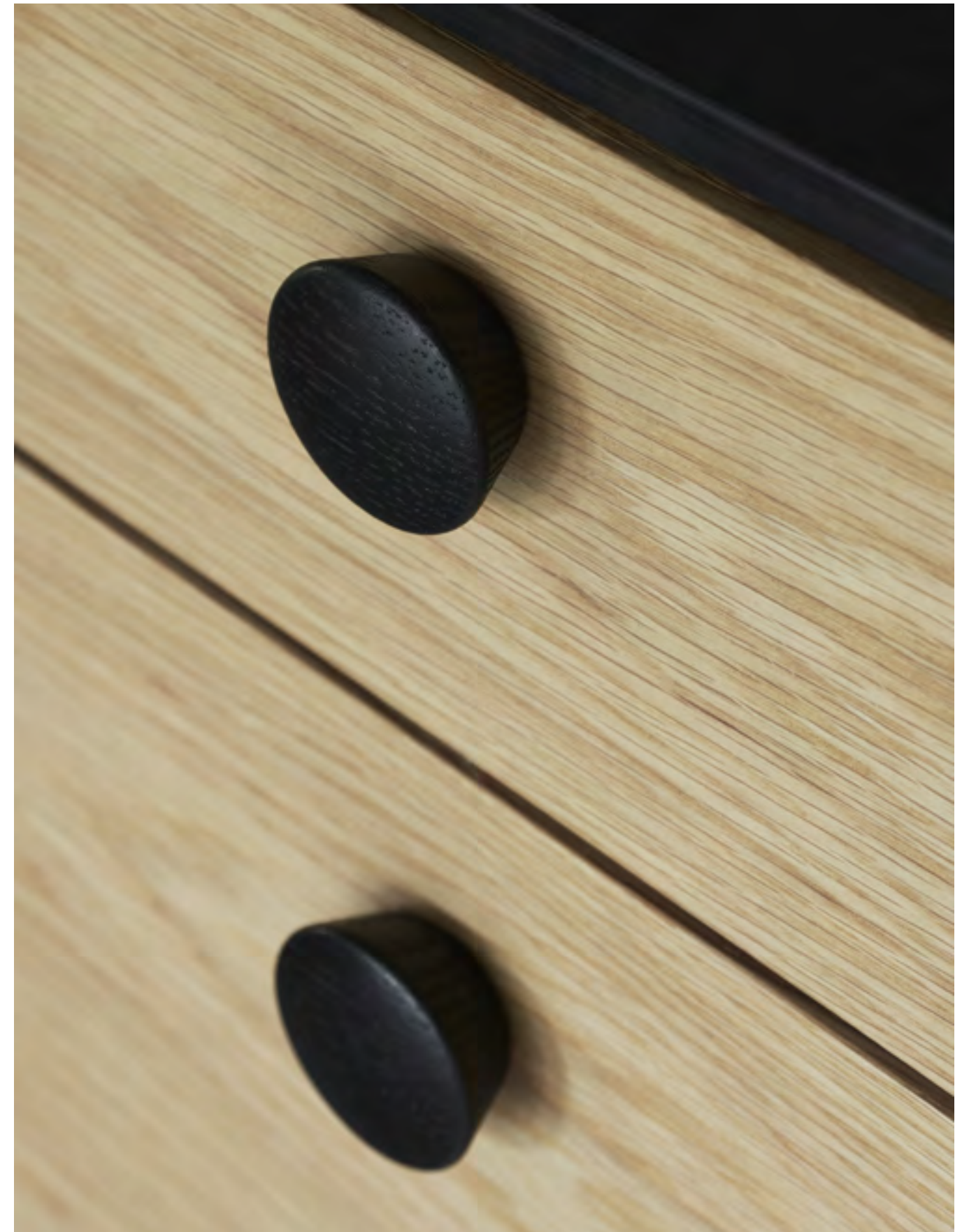

Model Beret - page 128



Model D-Lite - page 31 & 138



Model Slope - page 166

BOBBIN SLIM

Design furnipart
Material Steel

Finish	Reference	C/C	L	W	H	D
● Inox Look	208110012-25	-	-	-	24	12



BOUNCE

Design Steffensen & Würtz
Material Zamac

Finish	Reference	C/C	L	W	H	D
● Inox Look	546760016-66	-	-	-	34	16
● Matt Black	546760016-99	-	-	-	34	16



*matching handle BOUNCE - page 21

BYTE

Design furnipart
Material Stainless Steel

Finish	Reference	C/C	L	W	H	D
● Silk Polished	225230019-25	-	19	19	25	-



CANE

Design furnipart
Material Steel

Finish	Reference	C/C	L	W	H	D
● Inox Look	217710022-25	-	-	-	28	22



CASTLE

Design furnipart
Material Zamac

Finish	Reference	C/C	L	W	H	D
● Antique Grey	536660038-22.1	-	-	-	36	38
● Antique Brown	536660038-23.1	-	-	-	36	38
● Brushed Gold	536660038-33.1	-	-	-	36	38
● Inox Look	536660038-66.1	-	-	-	36	38



CLASSIC

Design Kamper Form
Material Zamac

Finish	Reference	C/C	L	W	H	D
● Antique Grey	536460034-22	-	-	-	28	34
● Antique Brown	536460034-23	-	-	-	28	34
● Inox Look	536460034-66	-	-	-	28	34
● Antique Copper	536460034-98	-	-	-	28	34



*matching handle CLASSIC - page 24

CONICAL

Design furnipart
Material Stainless Steel

Finish	Reference	C/C	L	W	H	D
● Silk Polished	221830050-2536	-	-	-	36	18



Model Classic - page 134

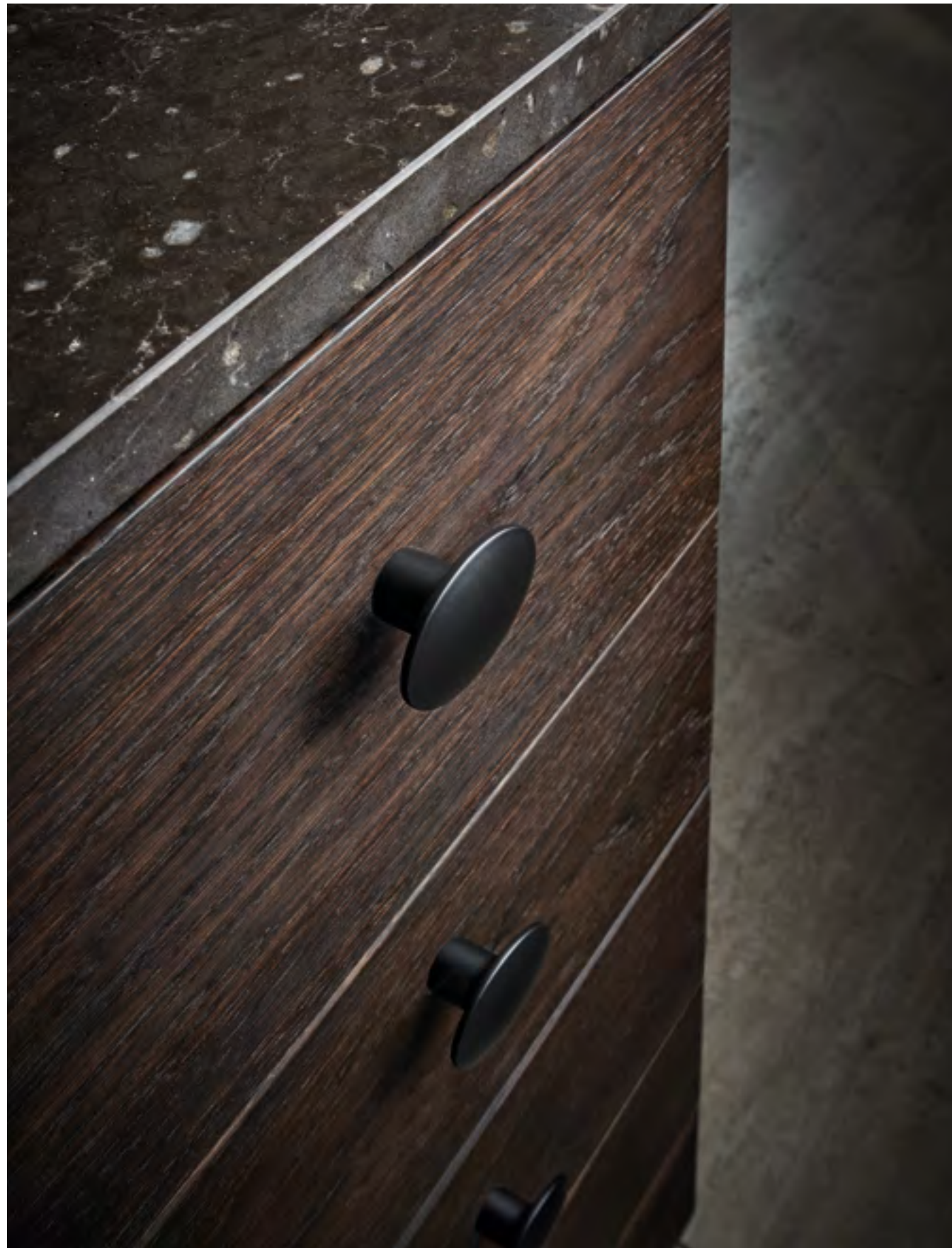

Model Dome - page 137

CURTAIN

Design furnipart
Material Stainless Steel

Finish	Reference	C/C	L	W	H	D
● Silk Polished	2224240050-25.1	-	50	-	40	20



DISC

Design Steffensen & Würtz
Material Zamac

Finish	Reference	C/C	L	W	H	D
● Brushed Brass	550120035-32	-	-	-	3	35
● Inox Look	550120035-66	-	-	-	3	35
● Brushed Anthracite	550120035-91	-	-	-	3	35
● Matt Black	550120035-99	-	-	-	3	35

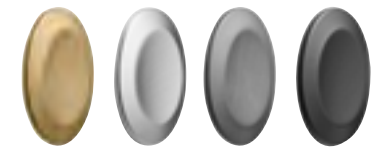

DOME

Design VE2
Material Zamac

Finish	Reference	C/C	L	W	H	D
● Brushed Brass	546960050-32	-	50	36	26	-
● Inox Look	546960050-66	-	50	36	26	-
● Matt Black	546960050-99	-	50	36	26	-



DOT

Design Hans Sandgren Jakobsen
Material Zamac

Finish	Reference	C/C	L	W	H	D
● Bright Chrome	511360030-08	-	-	-	26	30
● Inox Look	511360030-66	-	-	-	26	30
● Untreated Brass Polished	242530030-15	-	-	-	26	30



D-LITE

Design Adam Laws
Material Zamac

Finish	Reference	C/C	L	W	H	D
● Bright Nickel	552120032-06	32	44	12	32	-
● Gold	552120032-34	32	44	12	32	-
● Matt Black	552120032-99	32	44	12	32	-



*matching handle D-LITE - page 31

ECHO STRAIGHT

Design furnipart
Material Stainless Steel

Finish	Reference	C/C	L	W	H	D
● Silk Polished	207430010-25.1	-	-	-	20	10
● Silk Polished	207430015-25.1	-	-	-	30	15



Model Dot - page 138



Model Envelope - page 141

ECHO

Design furnipart
Material Stainless Steel

Finish	Reference	C/C	L	W	H	D
● Inox Look	217410020-25	-	-	-	25	20

**ELAN**

Design VE2
Material Aluminium

Finish	Reference	C/C	L	W	H	D
● Brushed Brass	453320032-31	32	50	20	-	-
● Inox Look	453320032-66	32	50	20	-	-
● Brushed Matt Black	453320032-76	32	50	20	-	-

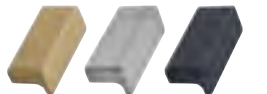

**matching handle ELAN - page 32*

ELE

Design Designit
Material Zamac

Finish	Reference	C/C	L	W	H	D
● Bright Chrome	516860032-08	32	100	16	25	-
● Inox Look	516860032-66	32	100	16	25	-



**matching handle ELE - page 35*

ENVELOPE

Design VE2
Material Aluminium

Finish	Reference	C/C	L	W	H	D
● Brushed Brass	449220032-31	32	50	24	25	-
● Inox Look	449220032-66	32	50	24	25	-
● Matt Black	449220032-76	32	50	24	25	-



**matching handle ENVELOPE - page 35*



Model Elan- page 141

FALL

Design VE2

Material Aluminium

Finish	Reference	C/C	L	W	H	D
● Inox Look	434320016-66	16	28	20	30	-
● Brushed Matt Black	434320016-76	16	28	20	30	-
● Antique Bronze	434320016-94	16	28	20	30	-

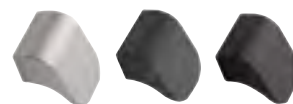

*matching handle FALL - page 36

FLEUR

Design Kamper Form

Material Cast Iron

Finish	Reference	C/C	L	W	H	D
● Black	300030046-9005	-	-	-	30	46

**FOLD**

Design Kamper Form

Material Zamac

Finish	Reference	C/C	L	W	H	D
● Antique Grey	537960032-22	32	40	18	32	-
● Antique Brown	537960032-23	32	40	18	32	-
● Inox Look	537960032-66	32	40	18	32	-



**matching handle FOLD - page 40

FUNNEL

Design furnipart

Material Stainless Steel

Finish	Reference	C/C	L	W	H	D
● Inox Look	217510020-25	-	-	-	21	20



Model Fleur - page 144

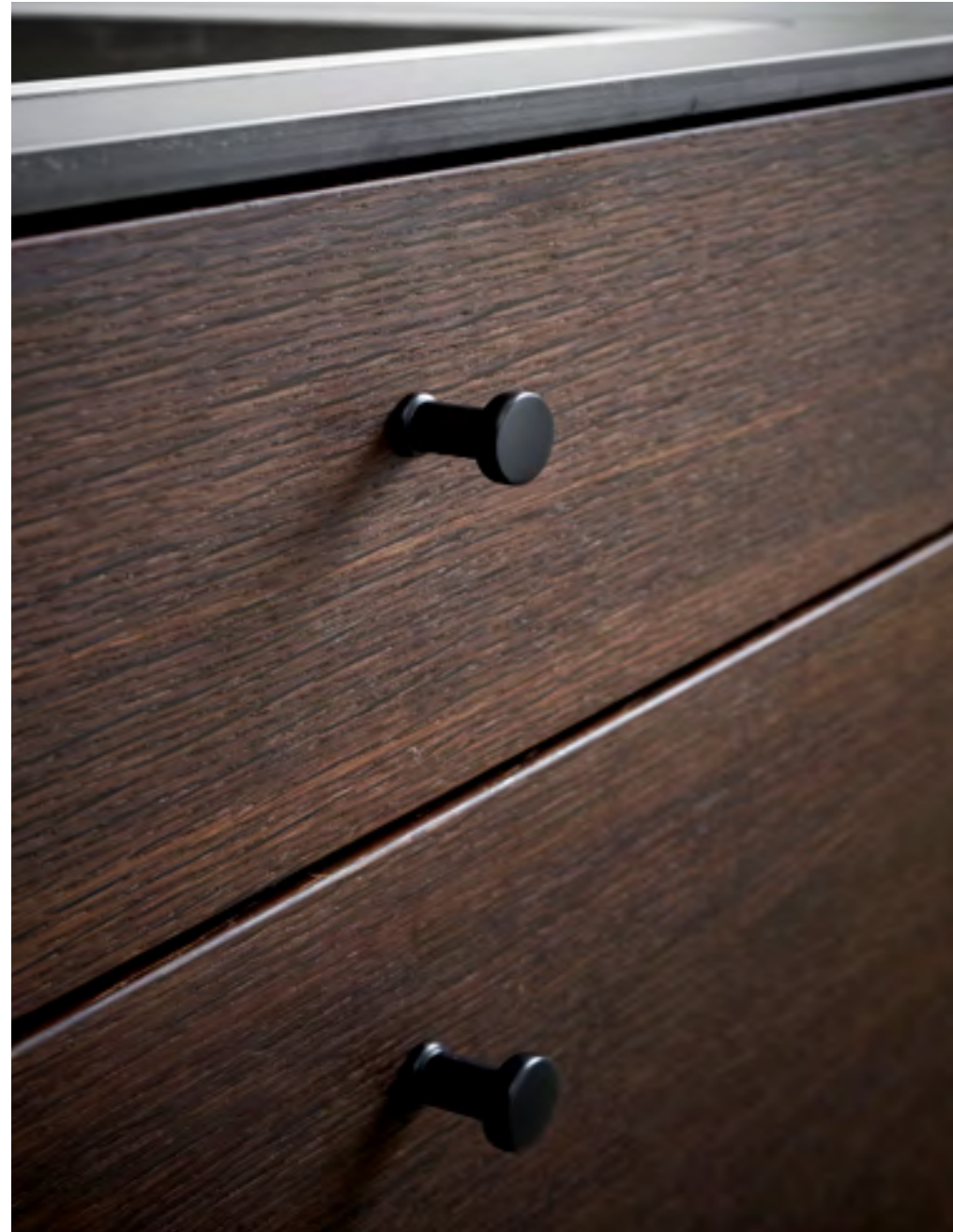

Model Gate - page 147

GATE

Design Adam Laws
Material Zamac

Finish	Reference	C/C	L	W	H	D
● Antique Brass	549820018-39	-	-	-	23	18
● Inox Look	549820018-66	-	-	-	23	18
● Matt Black	549820018-99	-	-	-	23	18



*matching handle GATE - page 43

GLOVE

Design kaschkasch
Material Zamac

Finish	Reference	C/C	L	W	H	D
● FSC 100% Oak Lacq.	103190032-052	32	55	24	26	-
● FSC 100% Black Ash	103190032-992	32	55	24	26	-



*matching handle GLOVE - page 43

HABIT

Design Steffensen & Würtz
Material Zamac

Finish	Reference	C/C	L	W	H	D
● Brushed Brass	547320050-32	-	50	30	4	-
● Inox Look	547320050-66	-	50	30	4	-
● Brushed Anthracite	547320050-91	-	50	30	4	-
● Matt Black	547320050-99	-	50	30	4	-

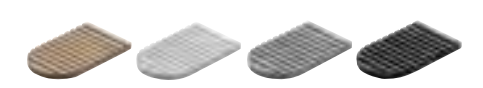

HALO

Design Adam Laws
Material Ceramic

Finish	Reference	C/C	L	W	H	D
○ White	601301016-0	16	75	37	31	-
● Black	601301016-9	16	75	37	31	-

**HARLEQUIN**

Design Meneghello Paoelli
Material Stainless Steel

Finish	Reference	C/C	L	W	H	D
● Silk Polished	240730017-25	-	-	24	33	17
● Black	240730017-9005	-	-	24	33	17

**HARLEQUIN**

Design Meneghello Paoelli
Material Stainless Steel

Finish	Reference	C/C	L	W	H	D
● Silk Polished	240830047-25	-	-	-	21	47
● Black	240830047-9005	-	-	-	21	47

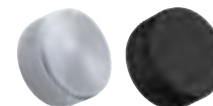

Model Inside - page 152



Model Horizon Small - page 151

HORIZON SMALL

Design Adam Laws
Material Zamac

Finish	Reference	C/C	L	W	H	D
● Matt White	553120032-0500	32	80	40	27	-
● Matt Black	553120032-99	32	80	40	27	-

**matching handle HORIZON LARGE - page 46*



HEXA

Design Rikke Frost
Material Zamac

Finish	Reference	C/C	L	W	H	D
● Antique Brass	550420024-39	-	-	24	29	27
● Inox Look	550420024-66	-	-	24	29	27
● Matt Black	550420024-99	-	-	24	29	27

**matching handle HEXA - page 46*



INK

Design kaschkasch
Material Cast Iron

Finish	Reference	C/C	L	W	H	D
● Black	300040032-9005	32	64	32	30	-



INSIDE

Design kaschkasch
Material Aluminium

Finish	Reference	C/C	L	W	H	D
● Inox Look	454220032-66	32	40	14	32	-
● Black	454220032-9005	32	40	14	32	-

*matching handle INSIDE - page 46



INVERT

Design Hans Sandgren Jakobsen
Material Aluminium

Finish	Reference	C/C	L	W	H	D
● Brushed Brass	445820032-31	32	40	34	23	-
● Inox Look	445820032-66	32	40	34	23	-
● Brushed Matt Black	445820032-76	32	40	34	23	-

*matching handle INVERT - page 49



KNOT

Design furnipart
Material Stainless Steel

Finish	Reference	C/C	L	W	H	D
● Silk Polished	238030075-25.2	-	75	-	44	12
● Black	238030075-9005.2	-	75	-	44	12



T-Knobs



Model Manor Round - page 155

LUCK

Design kaschkasch
Material Zamac

Finish	Reference	C/C	L	W	H	D
● Brushed Gold	544560032-33	32	41	8	40	-
● Inox Look	544560032-66	32	41	8	40	-
● Matt Black	544560032-99	32	41	8	40	-



*matching handle LUCK - page 53

MANOR ROUND

Design Kamper Form
Material Zamac

Finish	Reference	C/C	L	W	H	D
● Gold	549220025-34	-	-	-	35	30
● Antique Brass	549220025-39	-	-	-	35	30
● Matt Black	549220025-99	-	-	-	35	30



*matching handle MANOR - page 57

MANOR T

Design Kamper Form
Material Zamac

Finish	Reference	C/C	L	W	H	D
● Gold	549120054-34	-	54	-	39	30
● Antique Brass	549120054-39	-	54	-	39	30
● Matt Black	549120054-99	-	54	-	39	30



*matching handle MANOR BACK - page 57

MERCURY

Design Kamper Form
Material Zamac

Finish	Reference	C/C	L	W	H	D
● Antique Grey	536360016-22	16	54	16	32	-
● Antique Brown	536360016-23	16	54	16	32	-
● Inox Look	536360016-66	16	54	16	32	-



*matching handle MERCURY - page 58



MONTE

Design VE2
Material Marble

Finish	Reference	C/C	L	W	H	D
● White	800020035-WC	-	-	-	20	35

*matching handle MONTE - page 61

**MOTION**

Design Steffensen & Würtz
Material Cast Iron

Finish	Reference	C/C	L	W	H	D
● Black	300090022-9005	-	-	-	31	22

*matching handle MOTION - page 61

**MUSHROOM**

Design furnipart
Material Stainless Steel

Finish	Reference	C/C	L	W	H	D
● Inox Look	216810022-25	-	-	-	22	22

**ORBIT**

Design VE2
Material Zamac

Finish	Reference	C/C	L	W	H	D
● Inox Look	550820036-66	-	-	-	22	36
● Matt Black	550820036-99	-	-	-	22	36



Model Orbit - page 158



Model Oval Simple - page 161

OVAL CERAMIC

Design furnipart
Material Ceramic

Finish	Reference	C/C	L	W	H	D
○ White	600901060-0	-	60	35	38	30
● Matt Black	600901060-9	-	60	35	38	30



OVAL

Design furnipart
Material Zamac

Finish	Reference	C/C	L	W	H	D
○ Inox Look	514960060-66	-	60	35	38	-
● Antique Gold	514960060-91T	-	60	35	38	-
● Antique Black Brass	514960060-93	-	60	35	38	-
● Matt Black	514960060-99	-	60	35	38	-



*matching handle OVAL - page 62

OVAL SIMPLE

Design furnipart
Material Zamac

Finish	Reference	C/C	L	W	H	D
● Antique Grey	525060060/22-P.2	-	60	35	38	26
● Antique Brown	525060060/23-P.2	-	60	35	38	26
○ Inox Look	525060060/66	-	60	35	38	26
● Matt Black	525060060/99-P.2	-	60	35	38	26



PAGODA

Design Kamper Form
Material Cast Iron

Finish	Reference	C/C	L	W	H	D
● Black	300060032-9005	32	44	13	33	-

**matching handle PAGODA - page 62*

**PILLAR**

Design Steffensen & Würtz
Material Zamac

Finish	Reference	C/C	L	W	H	D
● Antique Brass	547720015-39	-	-	-	33	15
● Inox Look	547720015-66	-	-	-	33	15
● Matt Black	547720015-99	-	-	-	33	15



**matching handle PILLAR - page 65*

PLATO

Design Hans Sandgren Jakobsen
Material Aluminium

Finish	Reference	C/C	L	W	H	D
○ Matt White	441320042-0500	-	-	-	24	42
● Brushed Brass	441320042-31	-	-	-	24	42
● Inox Look	441320042-66	-	-	-	24	42
● Brushed Matt Black	441320042-76	-	-	-	24	42
● Brushed Anthracite	441320042-91	-	-	-	24	42



**matching handle SQUARE 10 - page 79*

PLATO OCEANIX

Design Hans Sandgren Jakobsen
Material OceanIX

Finish	Reference	C/C	L	W	H	D
● Dyed Black	700010042-86	-	-	-	24	42

**matching handle SQUARE 10 - page 79*



Model Plato OceanIX - page 162



Model Pulley - page 165

POINT

Design VE2
Material Zamac

Finish	Reference	C/C	L	W	H	D
● Brushed Gold	544960028-33	-	-	-	25	28
● Inox Look	544960028-66	-	-	-	25	28
● Matt Black	544960028-99	-	-	-	25	28



PULLEY

Design kaschkasch
Material Wood

Finish	Reference	C/C	L	W	H	D
● FSC 100% Oak Lacq.	103390045-052	-	-	-	22	45
● FSC 100% Black Ash	103390045-992	-	-	-	22	45



PUNCH

Design Adam Laws
Material Aluminium

Finish	Reference	C/C	L	W	H	D
● Brushed Brass	449420016-31	16	31	48	18	-
● Inox Look	449420016-66	16	31	48	18	-
● Brushed Matt Black	449420016-76	16	31	48	18	-



SCOPE

Design Rikke Frost
Material Zamac

Finish	Reference	C/C	L	W	H	D
● Inox Look	543060016-66	-	30	-	20	16
● Black	543060016-9005	-	30	-	20	16

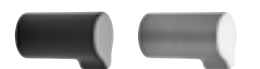

*matching handle SCOPE - page 75

SIMON

Design furnipart
Material Steel

Finish	Reference	C/C	L	W	H	D
● Inox Look	241930035-66	-	-	-	29	35
● Antique Brass	241930035-39	-	-	-	29	35
● Black	241930035-9005E	-	-	-	29	35

**SLOPE**

Design kaschkasch
Material Zamac

Finish	Reference	C/C	L	W	H	D
● Inox Look	550320016-66	16	35	25	31	-
● Matt Black	550320016-99	16	35	25	31	-



*matching handle SLOPE - page 79

STRAP

Design Adam Laws
Material Zamac/Leather

Finish	Reference	C/C	L	W	H	D
● Black	545560016-102/66	16	31	24	57	-
● Cognac	545560016-105/66	16	31	24	57	-
● Black	545560016-102/9005	16	31	24	57	-
● Cognac	545560016-105/9005	16	31	24	57	-



Model Simon - page 166



Tau & Punch - page 84, 165 & 169

STATION

Design Kamper Form
Material Aluminium

Finish	Reference	C/C	L	W	H	D
● Brushed Brass	437620032-31	32	44	22	25	-
● Inox Look	437620032-66	32	44	22	25	-
● Brushed Matt Black	437620032-76	32	44	22	25	-



*matching handle STATION - page 83

TAU

Design VE2
Material Aluminium

Finish	Reference	C/C	L	W	H	D
● Brushed Brass	446320032-31	32	126	10	25	-
● Inox Look	446320032-66	32	126	10	25	-
● Brushed Matt Black	446320032-76	32	126	10	25	-
● Brushed Anthracite	446320032-91	32	126	10	25	-



*matching handle TAU - page 84

TUG

Design Steffensen & Würtz
Material Aluminium

Finish	Reference	C/C	L	W	H	D
● Inox Look	453220020-66	18	20	51	-	30
● Brushed Matt Black	453220020-76	18	20	51	-	30



TULIP

Design furnipart
Material Zamac

Finish	Reference	C/C	L	W	H	D
● Inox Look	517960038-66	-	-	-	36	38



TRAIL

Design Kamper Form

Material Zamac

Finish	Reference	C/C	L	W	H	D
● Antique Brown	538760016-23	16	48	26	32	-
● Inox Look	538760016-66	16	48	26	32	-

*matching handle TRAIL - page 87

**TUMBLER**

Design furnipart

Material Lead Free Brass

Finish	Reference	C/C	L	W	H	D
● Untreated Brass Polished	242230021-15	-	-	-	26	21

**TRANSIT**

Design VE2

Material Zamac

Finish	Reference	C/C	L	W	H	D
● Inox Look	550720016-66	16	25	32	24	-
● Matt Black	550720016-99	16	25	32	24	-

*matching handle TRANSIT - page 87

**VANILLA**

Design Kamper Form

Material Ceramic

Finish	Reference	C/C	L	W	H	D
○ White	601201016-0	16	50	30	26	-

*matching handle VANILLA - page 91



Model Transit - page 170



Model Tug - page 169

VILLA ROUND

Design Kamper Form
Material Zamac

Finish	Reference	C/C	L	W	H	D
● Bright Nickel	552920030-06	64	100	30	20	30
● Black Nickel	552920030-70	64	100	30	20	30

*matching handle VILLA - page 91



VOTE

Design VE2
Material Zamac

Finish	Reference	C/C	L	W	H	D
● Inox Look	531360040-66	-	-	-	37	40



ZEPPELIN

Design furnipart
Material Zamac

Finish	Reference	C/C	L	W	H	D
● Bright Chrome	530460053-08/OR	-	52	21	40	-
● Antique Grey	530460053-22/OR	-	52	21	40	-
● Inox Look	530460053-66/OR	-	52	21	40	-
● Matt Black	530460053-99/OR	-	52	21	40	-



OUR DESIGNERS

furnipart has a long tradition of collaborating with both well-established and new designers from all around the world. We take great pride in finding unique designs that fit perfectly into our collection, so when we find a new design partner, we always make a careful assessment to ensure they fit into furnipart's ethos and culture.

Adam Laws

Adam Laws is a native Australian designer whose studio is located in Sydney. His creative form concepts and innovative technical design solutions have been awarded over 20 design awards. His back catalogue of work includes brands such as Harley Davidson (USA), Youmans Capsule (New Zealand) and ChessPlus (Australia). Adam Laws is regularly enthused by Australia's beautiful and wild nature, and several of the designs he has created for furnipart have been inspired by the sea. Adam Laws is responsible for designing EDGE STRAIGHT, which has been a staple of our collection since 2012. The continual popularity of EDGE STRAIGHT has only increased over time and new colours are lengths are still being added today.



Hans Sandgren Jakobsen

You will find Hans Sandgren Jakobsen's studio located in a beautiful old harbour front building, practically on the quay edge in the Port of Grenaa. The American shaker movement's approach to furniture design, where beauty depends on functionality is a consistent influence throughout his work, such as in furniture for the

Danish Naver Collection, Japanese Kohseki CO. Ltd. and Sono AmbraTM's wooden loudspeakers. Hans

Sandgren Jakobsen's designs are above all functional. In collaboration with furnipart, he has created various handles and knobs, all with a clear reference to the Scandinavian design tradition and a light and simple design philosophy. It is clear from his designs and solutions that Hans Sandgren Jakobsen follows the mantra that less

is more.

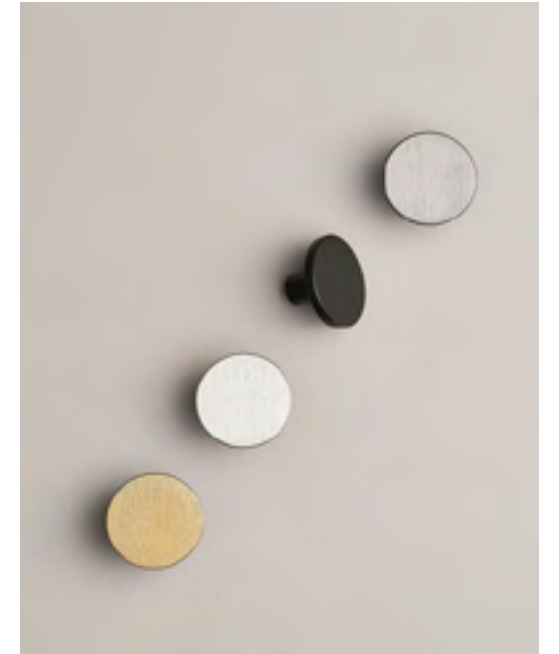

Kamper Form

Jakob Kamper is the man behind the design studio Kamper Form. He graduated as an industrial designer at Denmark's Design School (now part of The Royal Danish Academy of Fine Arts Schools of Architecture, Design and Conservation) in 2001 and his design studio is located in Ry. Kamper Form's designs are based on the idea that form should be a living thing, they should make an impression and suit the interiors of not just today but also tomorrow. Since Jakob Kamper often works with wood, his designs have proved very popular, especially at Skagerak. The collaboration with furnipart has resulted in many handles and knobs in the regular collection. For example, a handle like STATION is a beautiful example of Kamper Form's timeless look. The handle's clean lines function equally well in traditional and modern interiors, and the handle itself completely changes in character when its colour is changed.



kaschkasch

The German design studio kaschkasch was founded in 2011 by Florian Kallus and Sebastian Schneider. Located in Cologne, the studio works in furniture, lighting design and art direction. kaschkasch has a large back catalogue of designs for major international brands. At first glance their work appears formal but on closer inspection the design reveals a provocative and intelligent mode of expression, which seeks to question prevailing norms and offers new answers to existing everyday demands. Since 2019, kaschkasch has been designing handles and knobs for furnipart. Thus far the collection includes 18 of their designs in materials such as wood, aluminium and cast iron.

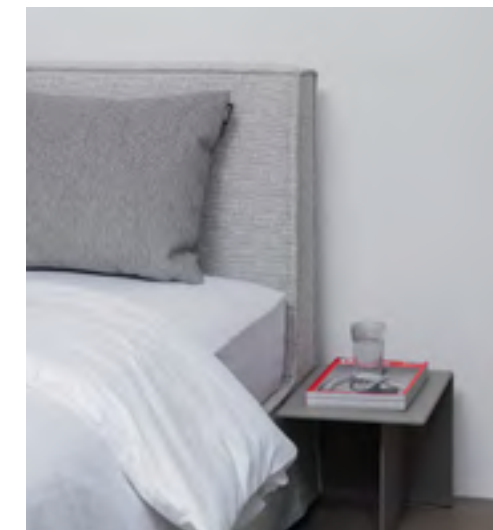

Meike Neuhaus

A small house on the edge of the forest forms the inspiring setting for designer Meike Neuhaus' aesthetic creations. Meike Neuhaus, the founder of neuhaus industrial design (2003), works best with all her versatile designs in a calm and peaceful environment. This natural environment inspires Meike Neuhaus to create such things as scenography for TV, stands for trade fairs and events, interior design, product design such as exclusive furniture handles and machine houses for components in plant construction. The challenging versatility is what Meike Neuhaus appreciates in her work above all else. The goal of Meike Neuhaus, who is a trained cabinetmaker with a degree in Industrial Design, is to create something unique. Meike Neuhaus' talent, specialist knowledge and execution are all interdependent; every design piece is as unmistakable and characterful as the respective customer.



Meneghello Paoletti

The design studio, Meneghello Paoletti Associati, is located in Milan and consists of two designers – Sandro Meneghello and Marco Paoletti. Their collaboration with furnipart started in 2016, and despite this relatively young partnership, Meneghello Paoletti Associati has already made a considerable impact within our collections and they have designed handles that we already consider to be 'classics'. Meneghello Paoletti Associati has collaborated with many brands, including Artceram, Nobili and Ceramica Bardelli.

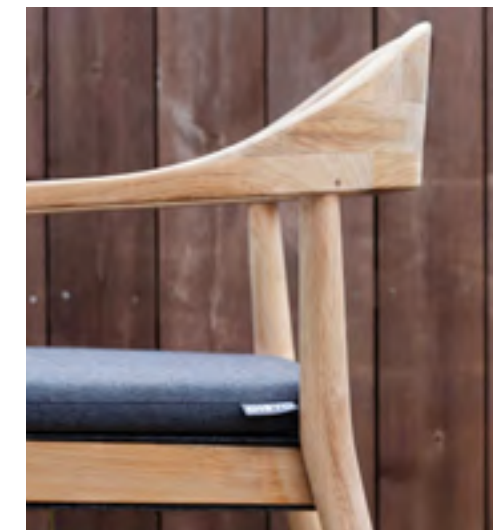

Rikke Frost

Rikke Frost first became well-known when she participated in the TV series “Danmarks næste klassiker” (Denmark’s next classic designs), which was broadcast on DR1 during the spring of 2019. Rikke Frost was named the overall winner with her furniture designed for children, which was created in collaboration with Kjeldtoft Furniture and Flexa. The BUKKI design is very indicative of Rikke Frost’s work. She loves to combine materials and make her designs tactile, as well as give them a functional and visual dimension. Her designs often have surprising details, as in the handle EDGE Filigree (launched in furnipart’s collection in 2017), which won a German Design Award in 2018.

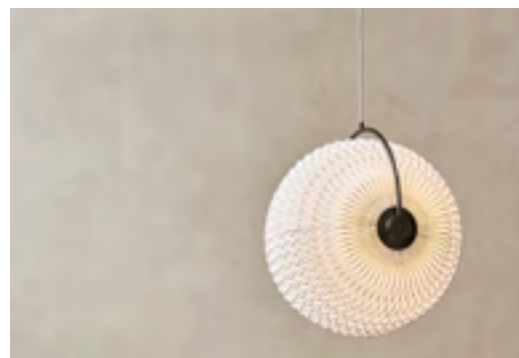

Steffensen & Würtz

Designers Thomas Steffensen and Pia Würtz Mogensen are the founders of design studio Steffensen & Würtz. They work with industrial design in their studio in Aalborg. Thomas Steffensen and Pia Würtz Mogensen both have an MA in Industrial Design. They have collaborated with several Danish and foreign brands, including Bolia and German kitchen manufacturer Allmilmö. They got off to a flying start and began collaborating with furnipart in 2020 and contributed towards furnipart’s successful 020 Collection. The ‘handle’ HABIT is hugely popular with the innovative way it has solved an irritating real issue from everyday life.



VE2

VE2 is Morten Lauritzen and Hugo Dines Schmidt. Founded in 2007, the design studio is located in Aarhus. Both designers are graduates of Aarhus School of Architecture and they focus on durable designs which are based on quality, honesty and the designs' ability to create aesthetic and functional value for the user. Since its foundation, the studio has earned huge respect at home and abroad for brands such as Zone Denmark and Skagerak.



RECESSED HANDLES

BACK

Design furnipart
Material Zamac

Finish	Reference	C/C	L	W	H	D
● Inox Look	515560064-66S	64	112	16	20	-
○ White	515560128-9010	128	200	15	20	-
● Inox Look	515560128-66S	128	200	15	20	-

**FLUSH**

Design furnipart
Material Zamac

Finish	Reference	C/C	L	W	H	D
● Inox Look	513660032-66	32	58	-	-	-

**HIDE**

Design furnipart
Material Zamac

Finish	Reference	C/C	L	W	H	D
● Inox Look	515565128-66S	128	200	16	31	-

**INN 50X50**

Design furnipart
Material Zamac

Finish	Reference	C/C	L	W	H	D
● Matt Chrome	512160050-09	-	50	50	12	-
● Inox Look	512160050-66	-	50	50	12	-



Model Inn 50x50 - page 188



Lux & Inn - page 191 & 192

INN 70X120

Design furnipart
Material Zamac

Finish	Reference	C/C	L	W	H	D
● Matt Chrome	512160120-09	-	120	70	12	-
● Inox Look	512160120-66	-	120	70	12	-

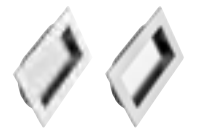

INN 50X160

Design furnipart
Material Zamac

Finish	Reference	C/C	L	W	H	D
● Matt Chrome	512160160-09	-	160	50	12	-
● Brushed Gold	512160160-33	-	160	50	12	-
● Inox Look	512160160-66	-	160	50	12	-
● Matt Black	512160160-99	-	160	50	12	-

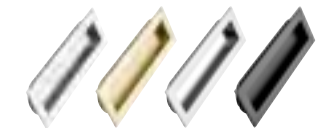

INN 50X202

Design furnipart
Material Zamac

Finish	Reference	C/C	L	W	H	D
● Bright Chrome	512160192-08	192	202	50	14	-
● Inox Look	512160192-66	192	202	50	14	-
● Matt Black	512160192-99	192	202	50	14	-

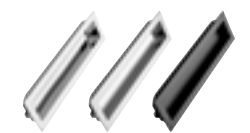

LUX

Design VE2
Material Zamac

Finish	Reference	C/C	L	W	H	D
● Bright Chrome	532160128-08	128	144	46	16	-
● Inox Look	532160128-66	128	144	46	16	-
● Matt Black	532160128-99	128	144	46	16	-
● Inox Look	532160192-66	192	208	46	16	-
● Matt Black	532160192-99	192	208	46	16	-

**OVAL**

Design furnipart
Material Stainless Steel

Finish	Reference	C/C	L	W	H	D
● Silk Polished	220430120-25	-	120	41	14	-

**POCKET**

Design furnipart
Material Zamac

Finish	Reference	C/C	L	W	H	D
● Inox Look	535260128-66S	128	200	17	25	-



Model Tub Round - page 195



Model Tub Straight - page 195

ROUND

Design furnipart
Material Stainless Steel

Finish	Reference	C/C	L	W	H	D
● Silk Polished	220230050-25.1	-	50	50	13	50
● Silk Polished	220230065-25.1	-	65	65	16	65



SQUARE

Design furnipart
Material Stainless Steel

Finish	Reference	C/C	L	W	H	D
● Silk Polished	220530102-25.1	-	102	50	13	-



TUB ROUND

Design Adam Laws
Material Zamac

Finish	Reference	C/C	L	W	H	D
● Inox Look	552620065-66	52	19	-	19	65
● Matt Black	552620065-99	52	19	-	19	65



TUB STRAIGHT

Design Adam Laws
Material Zamac

Finish	Reference	C/C	L	W	H	D
● Inox Look	552720202-66	190	202	49	19	-
● Matt Black	552720202-99	190	202	49	19	-



QUALITY

A furnipart handle is characterised by its outstanding quality; quality that not only can be seen but felt. Nothing is left to chance when it comes to our handles.

Back in 2009, we decided to formulate our own furnipart quality standard based on the standards from the German kitchen industry. As a result, tests of geometry, mechanical strength and surface are now part of both our development and serial production. Our wear-and-tear-test is performed by the German test Institute LGA.

Tests are carried out at our own laboratory in Denmark as well as during production to ensure you receive our highest standard every time.

FSC™

A majority of furnipart's wooden handles are FSC certified. This means these handles are made with wood from well-managed forests. FSC, which stands for 'Forest Stewardship Council™', is an international non-profit organisation dedicated to promoting responsible forestry.

FSC certifies forests all over the world to ensure they meet the highest environmental and social standards. When you buy our FSC certified products, you can be confident they won't harm the world's forests.

For more info on what products carry the FSC certification please contact us.

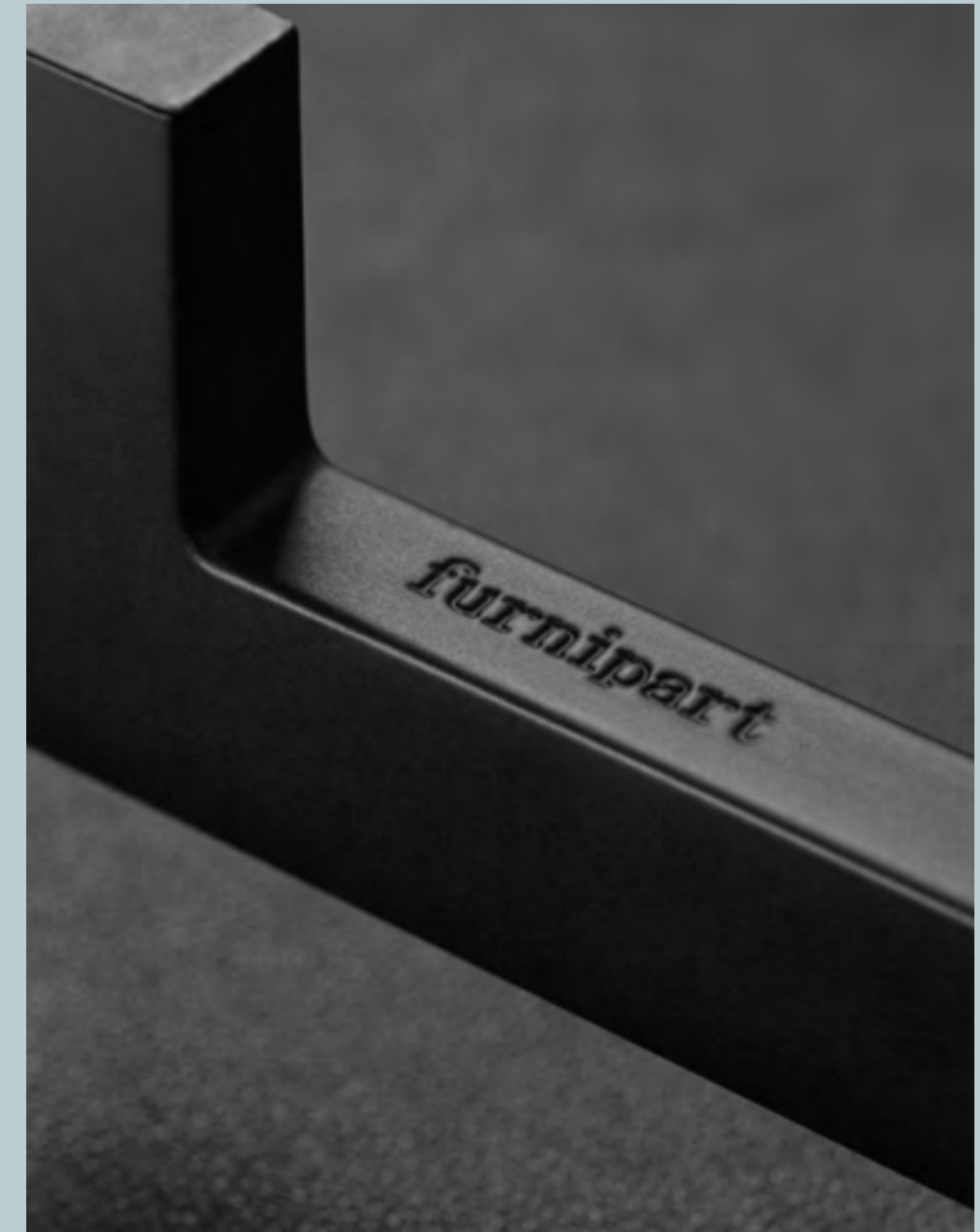

HOW WE DO IT?

- We work closely with renowned designers to get each handle and knob just right
- We carry out surface tests with the most common chemicals that are used in kitchens. Citric acid, alcohol and acetone are just some of the chemicals that are applied to the handles to test their resistance.
- We carry out cross-cut tests – both with and without water – to test the handle's corrosion resistance.
- If a design doesn't meet our quality requirements, a new pilot production must be started. We do all of this to ensure that the handle meets the standards that an original handle from furnipart must meet.
- Our quality control team do random tests to inspect the surface on our handles to ensure that both colour and gloss is exactly right. By checking colour and gloss, our customers are ensured that our products are the same every time.
- When the results of the tests are satisfactory, they are documented using a reference test handle, which future products are measured against. This means that we carry out incoming goods inspection on every shipment of handles that arrive from our production facility to ensure that the handles that we receive meet the set standards for the given design.



ECONOMIC HANDLE DESIGN

In certain scenarios, sometimes cost is just as important as great design. So, we have a vast selection of cast aluminium handles within our range. Being cast aluminium makes these handles more cost effective, without compromising on the aesthetics or furnipart quality.

Model Inside - page 46



Model Doppia - page 32



Model Seam - page 75



Model Tangerine - page 84



Model Light - page 49



Model Safe - page 75



Model Span - page 79



Model Square10 Cast Alu - page 80

CAST IRON

Our cast iron handles exemplify a substantial warmth and authenticity and can be suited to a great variety of interiors from the classic to modern design.

Model Art - page 17



Model Pen - page 62



Model Pagoda - page 162



Model Provence - page 65



Model Fleur - page 144



Model Pagoda - page 62



Model Motion - page 61



Model Motion - page 158

LONG HANDLES

Our collection of long handles accommodates the need of handles for tall cabinets and closet doors. Emphasizing the vertical lines of tall fronts, our long handles are a graphic design statement with clear functionality. These handles are not meant to be hidden though they can be discrete.



Model Big - Cut-to-size - page 18



Model Big & Regular2 - Cut-to-size - page 18 & 69



Model Mango - page 54



Model Mango - page 54



Model Elan - page 32



Model Elan - page 32

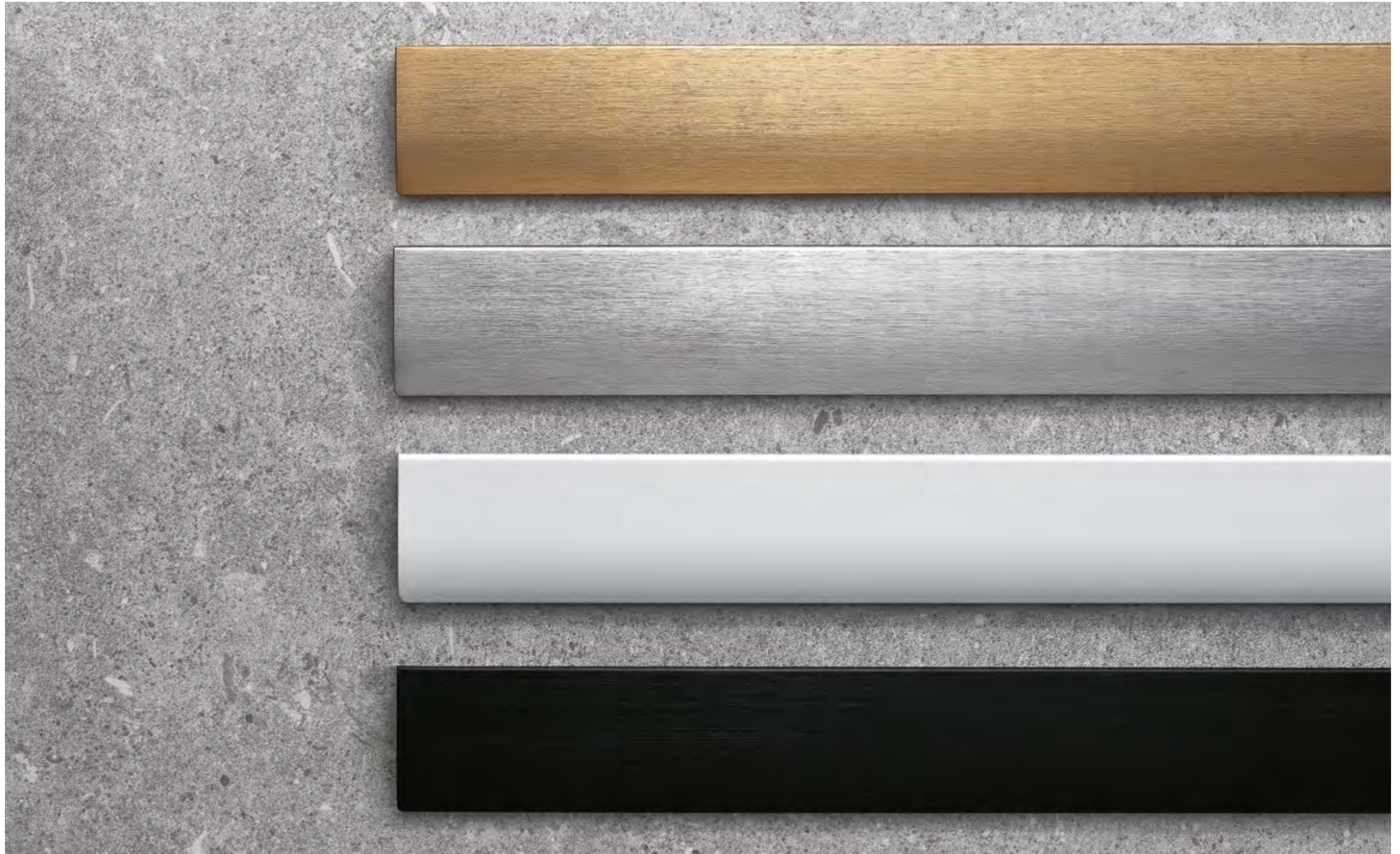

Edge Straight



Model Edge Straight - page 108



Model Edge Straight - page 111



Model Regular 2 - Cut-to-size - page 69



Model Regular 2 - Cut-to-size - page 69

PROFILE
REAR MOUNTED
EDGE TO EDGE

JAZZ

Design furnipart
Material Aluminium

Finish	Reference	C/C	L	W	H	D
● Inox Look	4300201962-66	2x74	196	40	16	-
● Inox Look	4300202962-66	2x124	296	40	16	-
● Inox Look	4300203462-66	3x116	346	40	16	-
● Inox Look	4300203962-66	4x99	396	40	16	-
● Inox Look	4300204462-66	4x112	446	40	16	-
● Inox Look	4300204962-66	5x109	496	40	16	-
● Inox Look	4300205962-66	8x93	596	40	16	-
● Inox Look	4300207962-66	9x94	796	40	16	-
● Inox Look	4300208962-66	10x94	896	40	16	-
● Inox Look	4300209962-66	12x95	996	40	16	-
● Inox Look	43002011962-66	12x95	1196	40	16	-



Model Jazz - page 228



Model Shadow (Straight) - page 231

SHADOW

Design Adam Laws
Material Aluminium

Finish	Reference	C/C	L	W	H	D
● Inox Look	4266201955-66	80	195	42	18	-
● Inox Look	4266202955-66	2x90	295	42	18	-
● Inox Look	4266203955-66	2x140	3965	42	18	-
● Inox Look	4266204455-66	2x165	445	42	18	-
● Inox Look	4266204955-66	2x190	495	42	18	-
● Inox Look	4266205955-66	2x240	595	42	18	-
● Inox Look	4266207955-66	3x226	7965	42	18	-
● Inox Look	4266208955-66	3x260	895	42	18	-
● Inox Look	4266209955-66	4x220	995	42	18	-
● Inox Look	42662011955-66	4x270	1195	42	18	-



TORRANCE

Design Adam Laws
Material Aluminium

Finish	Reference	C/C	L	W	H	D
● Inox Look	427120195-66	80	196	42	18	-
● Inox Look	427120295-66	2x90	296	42	18	-
● Inox Look	427120395-66	2x140	396	42	18	-
● Inox Look	427120495-66	2x190	496	42	18	-
● Inox Look	427120595-66	2x240	596	42	18	-
● Inox Look	427120795-66	3x226	796	42	18	-
● Inox Look	427120895-66	3x260	896	42	18	-
● Inox Look	427120995-66	4x220	996	42	18	-
● Inox Look	4271201195-66	4x270	1196	42	18	-



Model Torrance - page 232

SHADOW (DOUBLE)

Design Adam Laws
Material Aluminium

Finish	Reference	C/C	L	W	H	D
● Inox Look	4267203955-66	2x140	396	42	18	-
● Inox Look	4267204955-66	2x190	496	42	18	-
● Inox Look	4267205955-66	2x240	596	42	18	-

TORRANCE (DOUBLE)

Design Adam Laws
Material Aluminium

Finish	Reference	C/C	L	W	H	D
● Inox Look	427220395-66	2x140	396	42	18	-
● Inox Look	427220495-66	2x190	496	42	18	-
● Inox Look	427220595-66	2x240	596	42	18	-

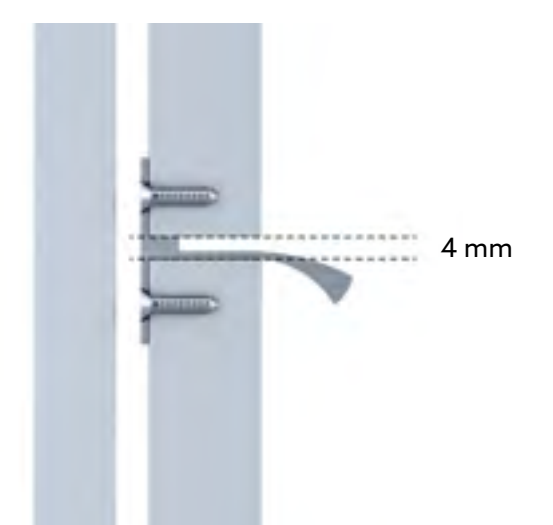
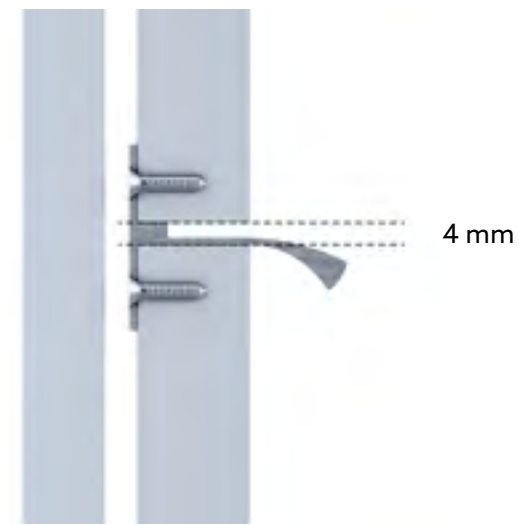
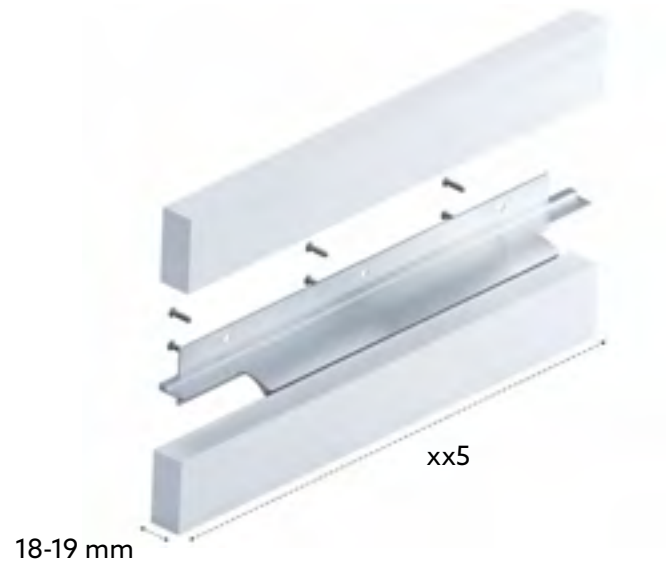



WALL

Design furnipart
Material Aluminium

Finish	Reference	C/C	L	W	H	D
● Inox Look	421020196-66	-	196	15/20	40	-
● Inox Look	421020296-66	-	296	15/20	40	-
● Inox Look	421020396-66	-	396	15/20	40	-
● Inox Look	421020446-66	-	446	15/20	40	-
● Inox Look	421020496-66	-	496	15/20	40	-
● Inox Look	421020596-66	-	596	15/20	40	-
● Inox Look	421020796-66	-	796	15/20	40	-
● Inox Look	421020896-66	-	896	15/20	40	-
● Inox Look	421020996-66	-	996	15/20	40	-
● Inox Look	4210201196-66	-	1196	15/20	40	-

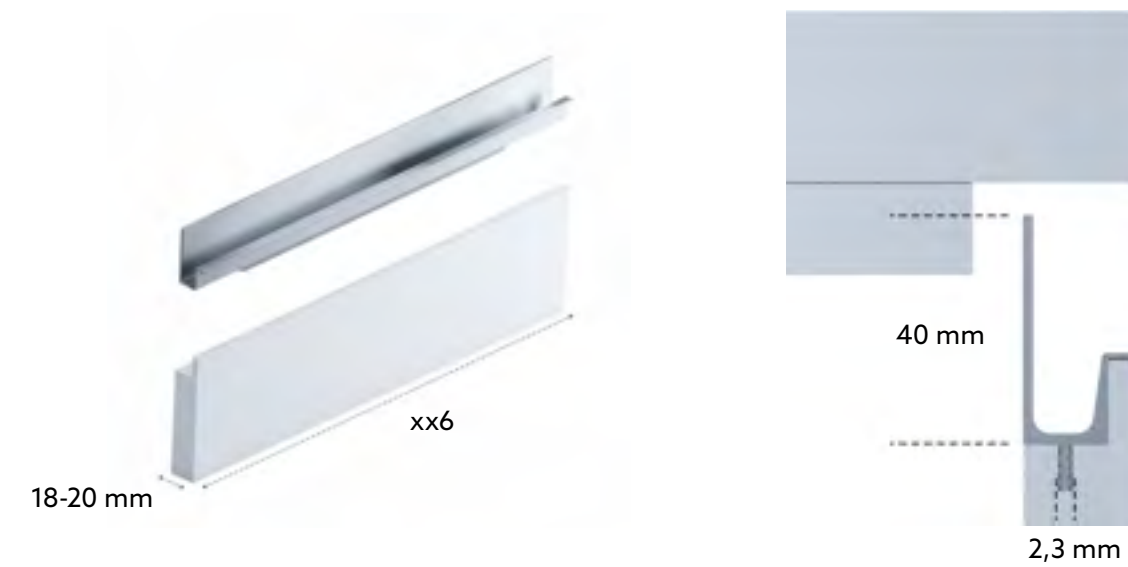

Model Wall - page 233

WALL DOUBLE

Design furnipart
Material Aluminium

Finish	Reference	C/C	L	W	H	D
● Inox Look	424420296-66	-	296	15/20	61/29	-
● Inox Look	424420396-66	-	396	15/20	61/29	-
● Inox Look	424420446-66	-	446	15/20	61/29	-
● Inox Look	424420496-66	-	496	15/20	61/29	-
● Inox Look	424420596-66	-	596	15/20	61/29	-

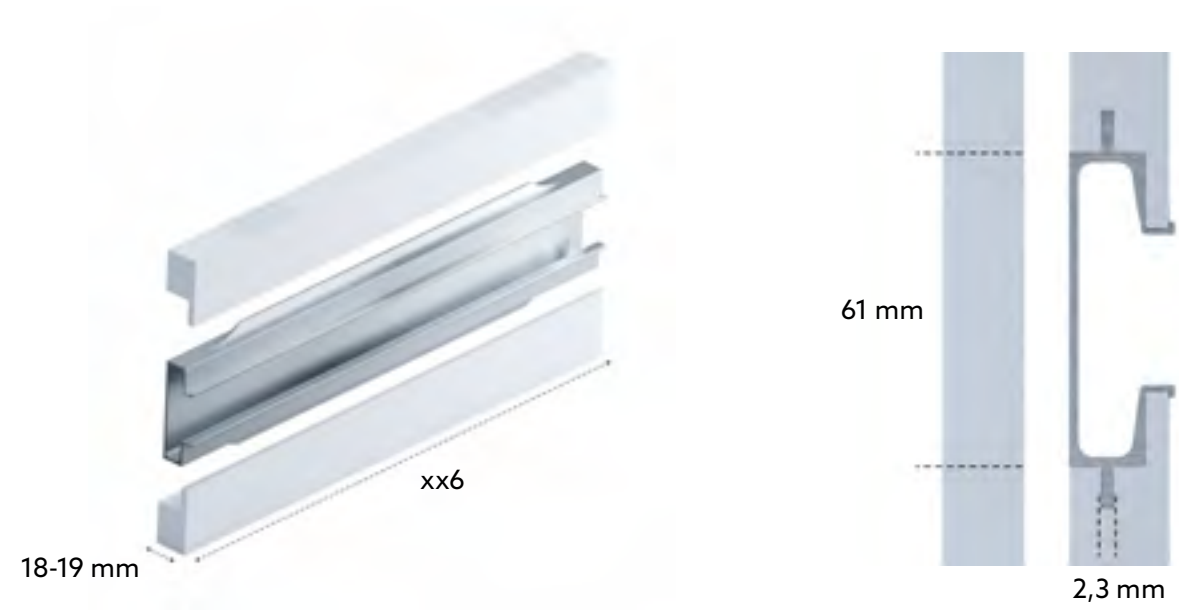

WALL UP

Design furnipart
Material Aluminium

Finish	Reference	C/C	L	W	H	D
● Inox Look	422720296-66	-	296	15/20	17	-
● Inox Look	422720346-66	-	346	15/20	17	-
● Inox Look	422720396-66	-	396	15/20	17	-
● Inox Look	422720446-66	-	446	15/20	17	-
● Inox Look	422720496-66	-	496	15/20	17	-
● Inox Look	422720596-66	-	596	15/20	17	-
● Inox Look	422720796-66	-	796	15/20	17	-
● Inox Look	422720896-66	-	896	15/20	17	-
● Inox Look	422720996-66	-	996	15/20	17	-
● Inox Look	4227201196-66	-	1196	15/20	17	-
● Inox Look	4227202000-66	-	2000	15/20	17	-



PROFILE
TOP MOUNTED
EDGE TO EDGE

CLIFF

Design furnipart
Material Aluminium

Finish	Reference	C/C	L	W	H	D
● Inox Look	425720146-66	-	146	21	15	-
● Inox Look	425720196-66	-	196	21	15	-
● Inox Look	425720296-66	-	296	21	15	-
● Inox Look	425720346-66	-	346	21	15	-
● Inox Look	425720396-66	-	396	21	15	-
● Inox Look	425720446-66	-	446	21	15	-
● Inox Look	425720496-66	-	496	21	15	-
● Inox Look	425720596-66	-	596	21	15	-
● Inox Look	425720696-66	-	696	21	15	-
● Inox Look	425720796-66	-	796	21	15	-
● Inox Look	425720896-66	-	896	21	15	-
● Inox Look	425720996-66	-	996	21	15	-
● Inox Look	4257201096-66	-	1096	21	15	-
● Inox Look	4257201196-66	-	1196	21	15	-
● Inox Look	4257202400-66	-	2400	21	15	-

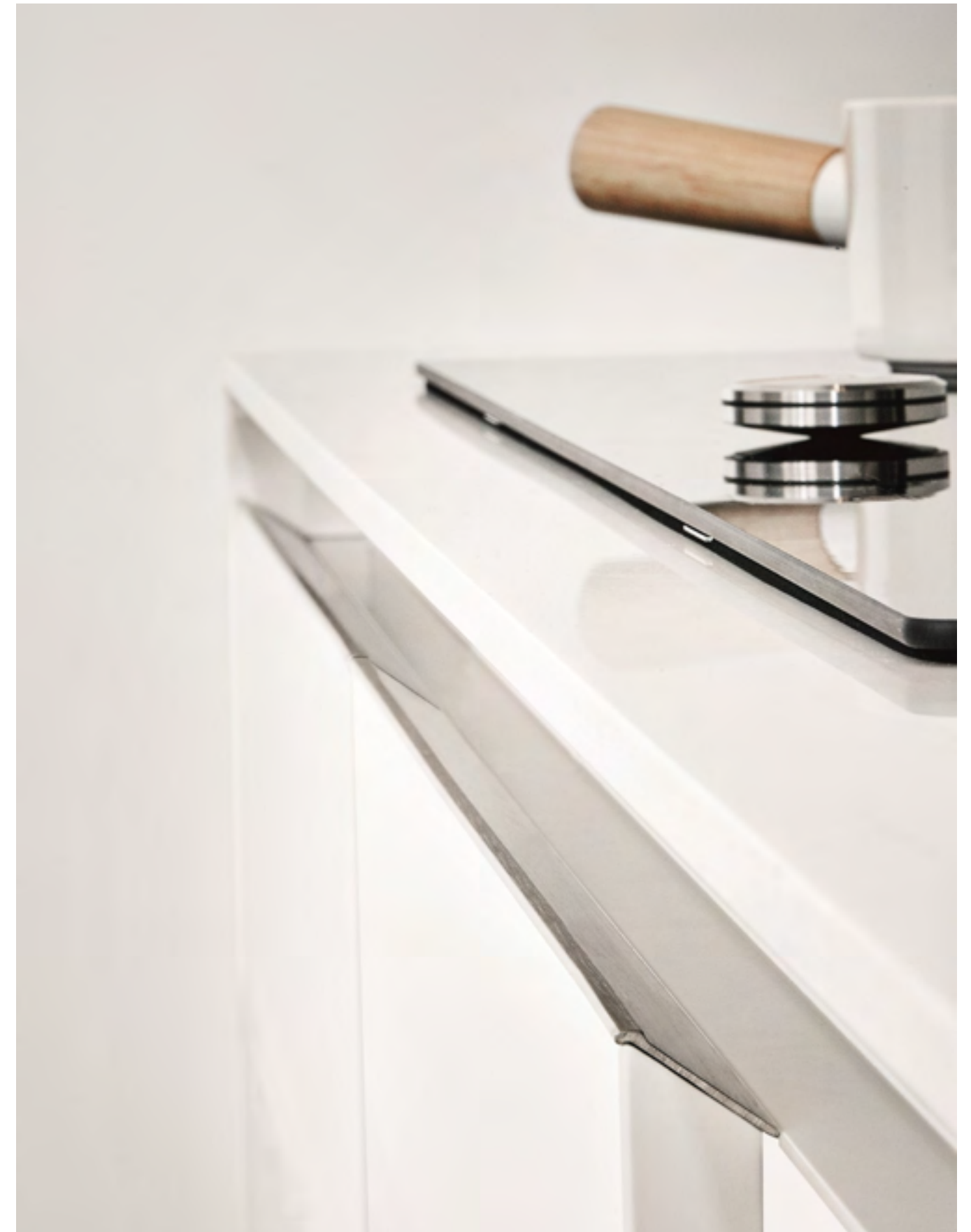
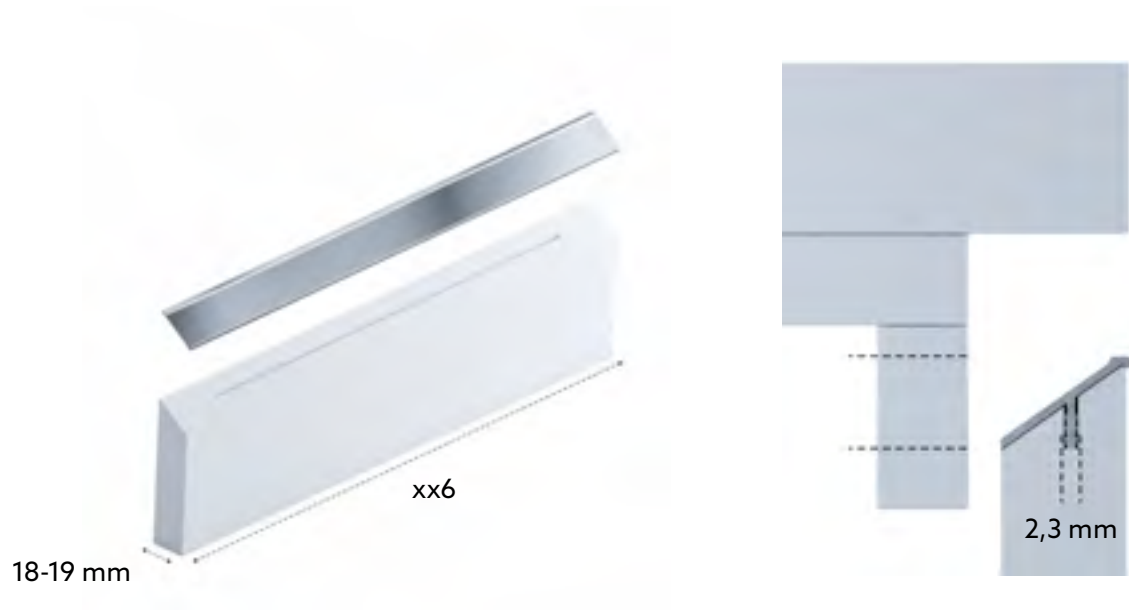

Model Cliff - page 238



CODA

Design furnipart
Material Zamac

Finish	Reference	C/C	L	W	H	D
● Inox Look	449920196-66	-	196	39	13	-
● Inox Look	449920296-66	-	296	39	13	-
● Inox Look	449920346-66	-	346	39	13	-
● Inox Look	449920396-66	-	396	39	13	-
● Inox Look	449920446-66	-	446	39	13	-
● Inox Look	449920496-66	-	496	39	13	-
● Inox Look	449920596-66	-	596	39	13	-
● Inox Look	449920696-66	-	696	39	13	-
● Inox Look	449920796-66	-	796	39	13	-
● Inox Look	449920896-66	-	896	39	13	-
● Inox Look	449920996-66	-	996	39	13	-
● Inox Look	4499201196-66	-	1196	39	13	-

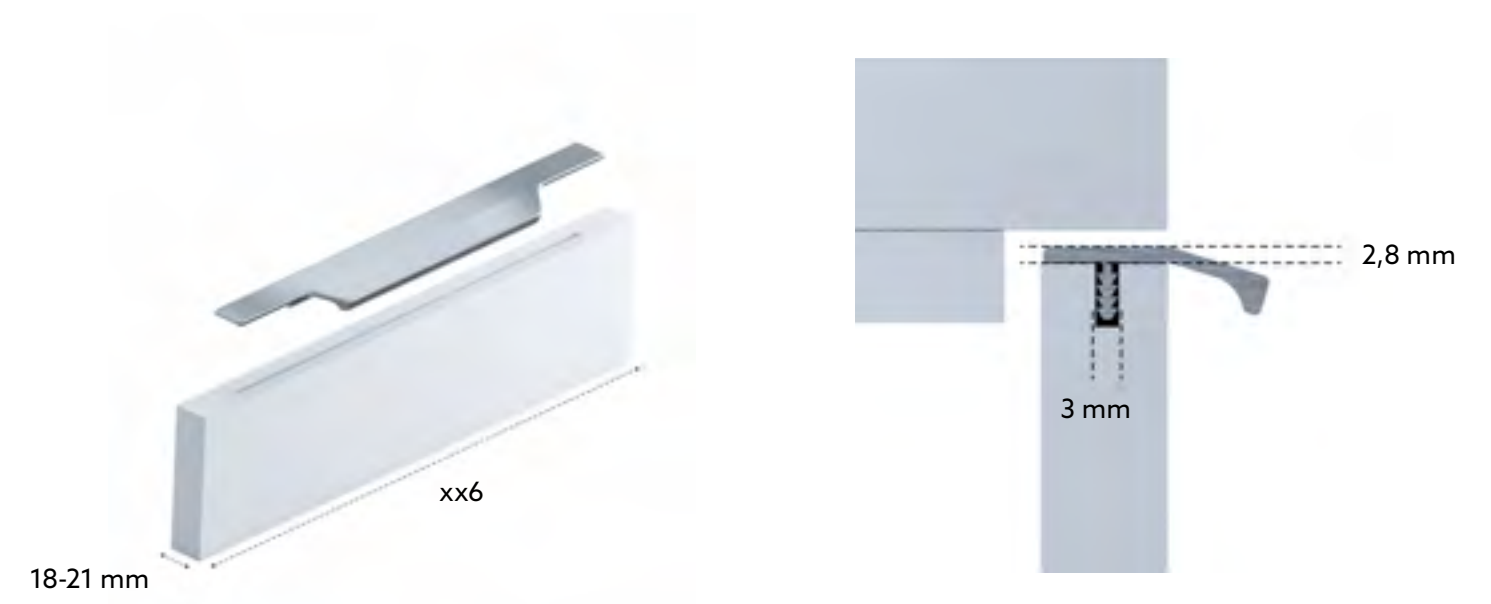

Model Coda - page 241

MALIBU

Design Adam Laws
Material Aluminium

Finish	Reference	C/C	L	W	H	D
● Inox Look	416420295-66	-	295	45	12	-
● Inox Look	416420296-66	-	296	45	12	-
● Inox Look	416420345-66	-	345	45	12	-
● Inox Look	416420346-66	-	346	45	12	-
● Inox Look	416420395-66	-	395	45	12	-
● Inox Look	416420396-66	-	396	45	12	-
● Inox Look	416420445-66	-	445	45	12	-
● Inox Look	416420446-66	-	446	45	12	-
● Inox Look	416420495-66	-	495	45	12	-
● Inox Look	416420496-66	-	496	45	12	-
● Inox Look	416420595-66	-	595	45	12	-
● Inox Look	416420596-66	-	596	45	12	-
● Inox Look	416420795-66	-	795	45	12	-
● Inox Look	416420796-66	-	796	45	12	-
● Inox Look	416420895-66	-	895	45	12	-
● Inox Look	416420896-66	-	896	45	12	-
● Inox Look	416420995-66	-	995	45	12	-
● Inox Look	416420996-66	-	996	45	12	-
● Inox Look	4164201195-66	-	1195	45	12	-
● Inox Look	4164201196-66	-	1196	45	12	-

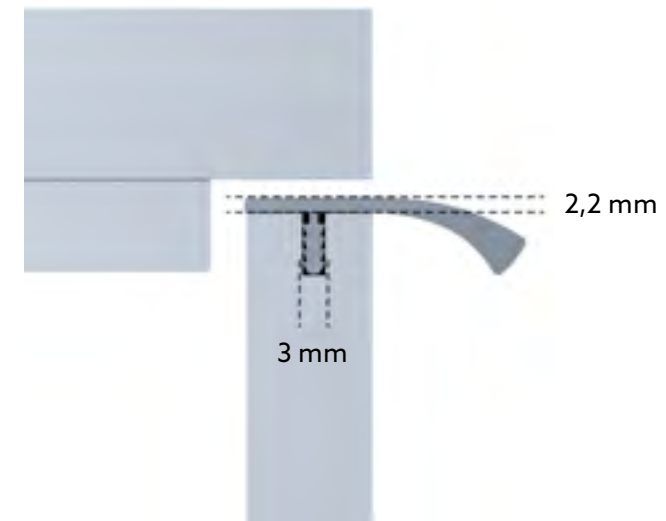

Model Malibu - page 242

TRIM

Design furnipart
Material Aluminium

Finish	Reference	C/C	L	W	H	D
● Natural Anod.	408020295-05.1	-	295	38	13	-
● Natural Anod.	408020345-05.1	-	345	38	13	-
● Natural Anod.	408020395-05.1	-	395	38	13	-
● Natural Anod.	408020445-05.1	-	445	38	13	-
● Natural Anod.	408020495-05.1	-	495	38	13	-
● Natural Anod.	408020595-05.1	-	595	38	13	-
● Natural Anod.	408020795-05.1	-	795	38	13	-
● Natural Anod.	408020895-05.1	-	895	38	13	-
● Natural Anod.	408020995-05.1	-	995	38	13	-
● Natural Anod.	4080201195-05.1	-	1195	38	13	-
● Bright Chrome	408020295-08	-	295	38	13	-
● Bright Chrome	408020345-08	-	345	38	13	-
● Bright Chrome	408020395-08	-	395	38	13	-
● Bright Chrome	408020445-08	-	445	38	13	-
● Bright Chrome	408020495-08	-	495	38	13	-
● Bright Chrome	408020595-08	-	595	38	13	-
● Bright Chrome	408020795-08	-	795	38	13	-
● Bright Chrome	408020895-08	-	895	38	13	-
● Bright Chrome	408020995-08	-	995	38	13	-
● Bright Chrome	4080201195-08	-	1195	38	13	-
● Brushed Brass	408020295-31.1	-	295	38	13	-
● Brushed Brass	408020345-31.1	-	345	38	13	-
● Brushed Brass	408020395-31.1	-	395	38	13	-
● Brushed Brass	408020495-31.1	-	445	38	13	-
● Brushed Brass	408020595-31.1	-	595	38	13	-
● Brushed Brass	408020645-31.1	-	1095	38	13	-
● Brushed Brass	408020695-31.1	-	1195	28	13	-
● Brushed Brass	408020745-31.1	-	745	38	13	-
● Brushed Brass	408020795-31.1	-	795	38	13	-
● Brushed Brass	408020895-31.1	-	895	38	13	-
● Brushed Brass	408020995-31.1	-	995	38	13	-
● Brushed Brass	4080201095-31.1	-	1095	28	13	-
● Brushed Brass	4080201195-31.1	-	1195	28	13	-

TRIM

Design furnipart
Material Aluminium

Finish	Reference	C/C	L	W	H	D
● Inox Look	408020295-66.1	-	295	38	13	-
● Inox Look	408020296-66.1	-	296	38	13	-
● Inox Look	408020297-66.1	-	297	38	13	-
● Inox Look	408020345-66.1	-	345	38	13	-
● Inox Look	408020346-66.1	-	346	38	13	-
● Inox Look	408020347-66.1	-	347	38	13	-
● Inox Look	408020395-66.1	-	395	38	13	-
● Inox Look	408020396-66.1	-	396	38	13	-
● Inox Look	408020397-66.1	-	397	38	13	-
● Inox Look	408020445-66.1	-	445	38	13	-
● Inox Look	408020446-66.1	-	446	38	13	-
● Inox Look	408020447-66.1	-	447	38	13	-
● Inox Look	408020495-66.1	-	495	38	13	-
● Inox Look	408020496-66.1	-	496	38	13	-
● Inox Look	408020497-66.1	-	497	38	13	-
● Inox Look	408020595-66.1	-	595	38	13	-
● Inox Look	408020596-66.1	-	596	38	13	-
● Inox Look	408020597-66.1	-	597	38	13	-
● Inox Look	408020795-66.1	-	795	38	13	-
● Inox Look	408020796-66.1	-	796	38	13	-
● Inox Look	408020797-66.1	-	797	38	13	-
● Inox Look	408020895-66.1	-	895	38	13	-
● Inox Look	408020896-66.1	-	896	38	13	-
● Inox Look	408020897-66.1	-	897	38	13	-
● Inox Look	408020995-66.1	-	995	38	13	-
● Inox Look	408020996-66.1	-	996	38	13	-
● Inox Look	408020997-66.1	-	997	38	13	-
● Inox Look	4080201195-66.1	-	1195	38	13	-
● Inox Look	4080201196-66.1	-	1196	38	13	-
● Inox Look	4080201197-66.1	-	1197	38	13	-
● Brushed Matt Black	408020296-76	-	296	38	13	-
● Brushed Matt Black	408020345-76	-	345	38	13	-
● Brushed Matt Black	408020346-76	-	346	38	13	-
● Brushed Matt Black	408020395-76	-	395	38	13	-
● Brushed Matt Black	408020396-76	-	396	38	13	-
● Brushed Matt Black	408020445-76	-	445	38	13	-
● Brushed Matt Black	408020446-76	-	446	38	13	-
● Brushed Matt Black	408020495-76	-	495	38	13	-
● Brushed Matt Black	408020496-76	-	496	38	13	-
● Brushed Matt Black	408020595-76	-	595	38	13	-
● Brushed Matt Black	408020596-76	-	596	38	13	-
● Brushed Matt Black	408020795-76	-	795	38	13	-
● Brushed Matt Black	408020796-76	-	796	38	13	-
● Brushed Matt Black	408020895-76	-	895	38	13	-
● Brushed Matt Black	408020896-76	-	896	38	13	-
● Brushed Matt Black	408020995-76	-	995	38	13	-
● Brushed Matt Black	408020996-76	-	996	38	13	-
● Brushed Matt Black	4080201195-76	-	1195	38	13	-
● Brushed Matt Black	4080201196-76	-	1196	38	13	-

TRIM

Design furnipart
Material Aluminium

Finish	Reference	C/C	L	W	H	D
● Antique Bronze	408020296-94.1	-	296	38	13	-
● Antique Bronze	408020396-94.1	-	396	38	13	-
● Antique Bronze	408020446-94.1	-	446	38	13	-
● Antique Bronze	408020496-94.1	-	496	38	13	-
● Antique Bronze	408020596-94.1	-	596	38	13	-
● Antique Bronze	408020796-94.1	-	796	38	13	-
● Antique Bronze	408020896-94.1	-	896	38	13	-
● Antique Bronze	408020996-94.1	-	996	38	13	-
● Antique Bronze	4080201196-94.1	-	1196	38	13	-

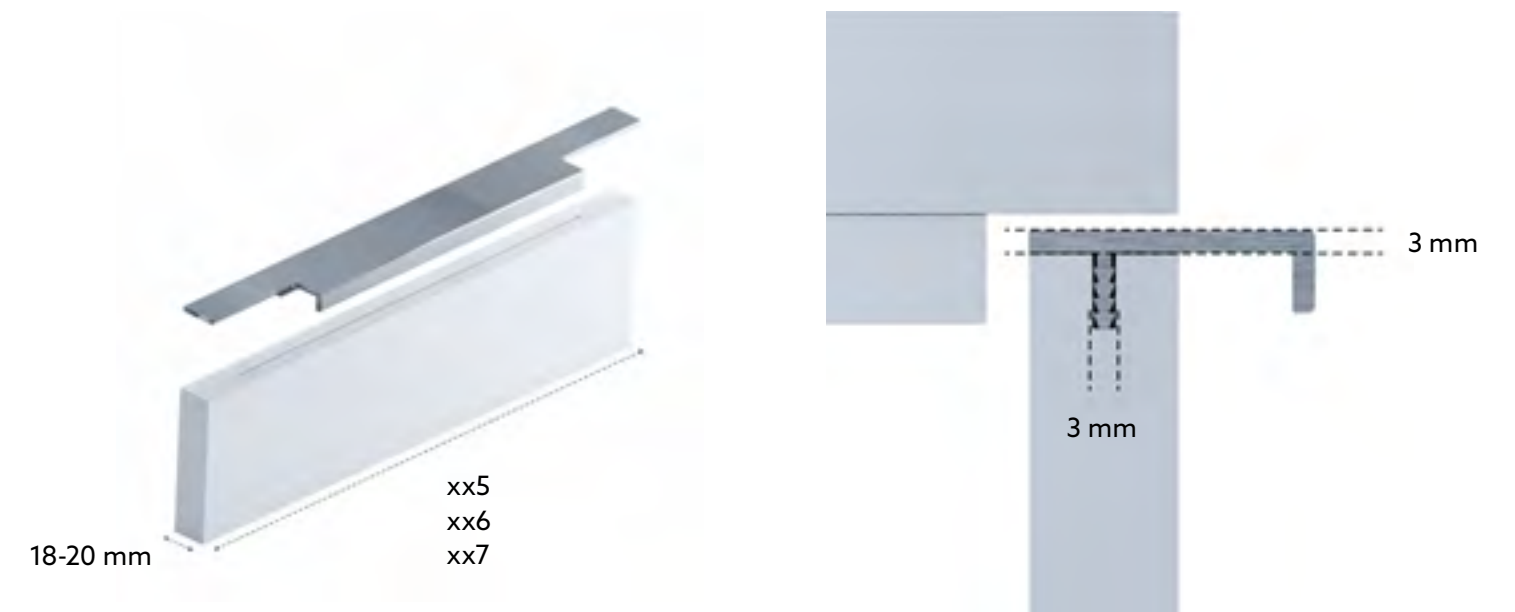

DID YOU ALSO KNOW?

- We send out over 100,000 handles to our kitchen and bathroom partners on a daily basis.
- Our warehouse facility is automated with nine AutoStore robots.
- A complete collection of all our images and technical drawings is accessible in our Media Library at furnipart.com
- All of our chrome and anodised aluminium profiles, as well as a considerable number of our Zamac products are Cradle to Cradle Certified® at bronze level.
- All products undergo a thorough quality inspection and testing – both at our production sites and in our laboratory in Denmark.



furnipart

delta 2
8382 hinnerup
denmark
+45 8764 3500
furnipart.com
fp@furnipart.com